

Innovative Technology

INTELLIGENCE IN VALIDATION

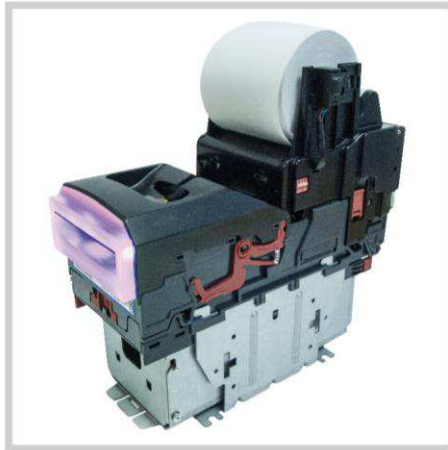

NV9 Range

[GA00550-3]

USER MANUAL

Document Name:	NV9 Range User Manual
Document Version:	1.6
Date of Release:	14/02/2023

TABLE OF CONTENTS

1	DOCUMENT INTRODUCTION	5
1.1	RELATED DOCUMENTS	5
1.2	MANUAL AMENDMENTS	5
1.3	COPYRIGHT	5
1.4	LIMITED WARRANTY	5
1.5	PRODUCT SAFETY INFORMATION	6
2	PRODUCT INTRODUCTION.....	8
2.1	GENERAL DESCRIPTION	8
2.2	KEY FEATURES	8
2.3	TYPICAL APPLICATIONS	8
2.4	COMPONENT OVERVIEW	8
2.5	BEZEL OPTIONS	10
2.6	CASHBOX OPTIONS.....	11
3	TECHNICAL DATA	12
3.1	DIMENSIONS	12
3.2	WEIGHT(S)	13
3.3	ENVIRONMENTAL REQUIREMENTS	13
3.4	POWER REQUIREMENTS	13
3.4.1	Supply Voltages.....	13
3.4.2	Supply Currents	13
3.4.3	Power Supply Guidance.....	14
3.5	INTERFACE LOGIC LEVELS	14
3.6	RELIABILITY DATA.....	14
3.7	MEDIA REQUIREMENTS	15
3.7.1	Notes.....	15
3.7.2	Tickets	15
3.7.2.1	Ticket Dimensions	15
3.7.2.2	Barcode Requirements	16
4	MECHANICAL INSTALLATION	18
4.1	COMPATIBILITY	18
4.1.1	Hardware Compatibility.....	18
4.1.1.1	Machine Mounting	18
4.1.1.2	Machine Interfacing.....	18
4.1.1.3	Power Supply	19
4.1.2	Software Compatibility	19



[<< Back to Contents](#)

4.1.2.1	Interface Protocols.....	19
4.1.2.2	Re-programming	19
4.2	BEZEL MOUNTING	20
4.2.1	<i>Bezel Fitting</i>	20
4.2.2	<i>Bezel Removal</i>	20
4.3	CASHBOX MOUNTING	21
4.3.1	<i>Cashbox Fitting</i>	21
4.3.2	<i>Cashbox Removal</i>	22
4.4	LOCK MOUNTING.....	23
4.4.1	<i>Lock Fitting</i>	23
4.4.2	<i>Lock Specifications</i>	24
4.4.3	<i>Lock Cam</i>	24
4.5	MACHINE MOUNTING.....	25
4.5.1	<i>Machine Mounting</i>	25
4.5.2	<i>Earth Bonding</i>	25
5	SOFTWARE INSTALLATION AND CONFIGURATION	26
5.1	INTRODUCTION	26
5.2	SOFTWARE DOWNLOADS	26
5.3	DRIVERS	26
5.4	DATASET/FIRMWARE PROGRAMMING	26
5.4.1	<i>Validator Manager</i>	26
5.4.1.1	General Description	26
5.4.1.2	System Requirements	26
5.4.1.3	Hardware Setup	27
5.4.1.4	Switching to Programming Mode (SSP).....	28
5.4.1.5	Programming the device.....	28
5.4.2	<i>DA3</i>	29
5.4.2.1	General Description	29
5.4.2.2	System Requirements	30
5.4.2.3	Re-programming via DA3.....	30
5.4.2.4	SMART Update DA3	31
5.4.3	<i>Remote Updates</i>	31
5.4.3.1	General Description	31
5.4.3.2	Software Requirements	31
5.4.4	<i>Configuration Card</i>	32
5.4.4.1	General Description	32
5.4.4.2	Hardware Requirements.....	32
5.4.4.3	Re-programming via Configuration Card.....	32
6	PROTOCOLS AND INTERFACING.....	33
6.1	INTRODUCTION	33
6.2	SSP AND ESSP	33
6.2.1	<i>General Description</i>	33
6.2.2	<i>Pin Assignments</i>	33
6.2.3	<i>Setup Examples</i>	34



[<< Back to Contents](#)

6.3	ccTALK®	37
6.3.1	General Description	37
6.3.2	Pin Assignments	37
6.3.3	ccTalk® DES Encryption	38
6.4	CC4	39
6.4.1	General Description	39
6.4.2	Pinout	39
6.5	SIO AND SI2	40
6.5.1	General Description	40
6.5.2	Pinout	40
6.6	MDB	41
6.6.1	General Description	41
6.6.2	IF5 Interface	41
6.7	PARALLEL	42
6.7.1	General Description	42
6.7.2	Pinout	42
6.7.3	Inhibit Control	43
6.7.4	Escrow Control	43
6.7.5	IF10 Interface	43
6.8	BINARY	44
6.8.1	General Description	44
6.8.2	Pinout	44
6.8.3	Inhibit Control	45
6.8.4	Escrow Control	45
6.8.5	IF9 Interface	45
6.9	PULSE	46
6.9.1	General Description	46
6.9.2	Pinout	46
6.9.3	Inhibit Control	47
6.9.4	Escrow Control	47
6.9.5	Credit Hold Function	47
6.9.6	IF15 Interface	47
7	ROUTINE MAINTENANCE	48
7.1	INTRODUCTION	48
7.2	RECOMMENDED CLEANING INTERVALS	48
7.3	RECOMMENDED BELT CHANGING INTERVALS	48
8	FIRST LEVEL SUPPORT	49
8.1	BEZEL LED FLASH CODES	49
8.2	STATUS LED FLASH CODES	50
8.3	CONFIGURATION BUTTON	51
8.4	DIP SWITCHES	52
9	SECOND LEVEL SUPPORT	53
9.1	INTRODUCTION	53



[<< Back to Contents](#)

9.2	FAULT FINDING CHART	53
9.3	CLEARING A JAM	54
9.4	CLEANING THE PRODUCT(S)	55
9.4.1	<i>NV9USB+/NV11+</i>	55
9.4.2	<i>Printer Head</i>	56
9.5	CHANGING THE DRIVE BELTS	57
9.6	CLEARING A CHECKSUM ERROR.....	58
9.7	TESTING AFTER AN ERROR HAS BEEN CLEARED	58
9.8	RE-INITIALISATION OF THE SENSORS	58
10	COMPLIANCES AND APPROVALS	59
10.1	EC DECLARATION OF CONFORMITY.....	59
11	APPENDIX.....	60
11.1	CABLE DRAWINGS	60
11.1.1	<i>CN00392 USB Type A to Validator Cable Assembly</i>	60
11.1.2	<i>CN00214 USB A to USB B Cable Assembly</i>	61
11.1.3	<i>WR00147 Smart Payout to NV200 Adaptor Harness</i>	62
11.1.4	<i>CN00398 Dual ESSP Interface</i>	63
11.1.5	<i>WR02043 NVR280 Harness Power and Data</i>	64
11.1.6	<i>WR02040 Host USB to NV9/10 split to Rainbow Bezel Cable Assembly</i>	65
11.2	CONNECTOR SPECIFICATIONS.....	66
11.3	LOCK SPECIFICATIONS	66
11.4	MEDIA SPECIFICATIONS	67
11.5	SWITCHING TO PROGRAMMING MODE (SSP).....	68
11.6	cCTALK DES ENCRYPTION – TRUSTED MODE	68
11.7	ESCROW CONTROL	70
11.7.1	<i>Escrow Timing Diagram</i>	71
11.8	LOW POWER MODE TIMING DIAGRAM	71
11.9	CONFIGURATION BUTTON FUNCTIONS.....	72
11.10	FILE NAMING CONVENTION	72
11.11	PROGRAMMING VIA CONFIGURATION CARD	73



1 DOCUMENT INTRODUCTION

1.1 Related Documents

This document should be read together with the following:

For SSP/eSSP:

Protocol Manual – SSP (GA138): SSP Interface Protocol Specification for integration

SSP Implementation Guide (GA973): Information for programmers and integrators

For other third-party interface protocols please contact support@innovative-technology.com.

1.2 Manual Amendments

Rev.	Date	Amendment Details	Issued by
1.0	06/07/2017	First Issue	DH
1.1	06/11/2019	NV12 & Cables	HJ
1.2	13/12/2019	Temperature	AV
1.3	20/11/2020	Added Bezel Options	CS
1.4	21/10/2022	Added bend cashbox recommendation	MG
1.5	11/01/2023	Added WR2040 and updated IF15	MG
1.6	14/02/2023	Added cashbox full acknowledge	MG

1.3 Copyright

This manual set is Copyright © Innovative Technology Ltd. 2017. No part of this publication may be reproduced in any form or by any means used to make any derivative such as translation, transformation, or adaptation without permission from Innovative Technology Ltd. The contents of this manual set may be subject to change without prior notice.

1.4 Limited Warranty

Innovative Technology Ltd warrants each of its hardware products to be free from defects in workmanship and materials under normal use and service for a period commencing on the date of purchase from Innovative Technology Ltd or its Authorized Reseller, and extending for the length of time stipulated by Innovative Technology Ltd.

A list of Innovative Technology Ltd offices can be found in every section of this manual set. If the product proves defective within the applicable warranty period, Innovative Technology Ltd will repair or replace the product. Innovative Technology Ltd shall have the sole discretion whether to repair or replace, and any replacement product supplied may be new or reconditioned.



[<< Back to Contents](#)

The foregoing warranties and remedies are exclusive and are in lieu of all other warranties, expressed or implied, either in fact or by operation of law, statutory or otherwise, including warranties of merchantability and fitness for a particular purpose.

Innovative Technology Ltd shall not be liable under this warranty if it's testing and examination disclose that the alleged defect in the product does not exist or was caused by the customer's or any third person's misuse, neglect, improper installation or testing, unauthorized attempts to repair, or any other cause beyond the range of the intended use. In no event will Innovative Technology Ltd be liable for any damages, including loss of profits, cost of cover or other incidental, consequential, or indirect damages arising out the installation, maintenance, use, performance, failure, or interruption of an Innovative Technology Ltd product, however caused.

1.5 Product Safety Information

Throughout this user manual, we may draw your attention to key safety points that you should be aware of when using or maintaining the product.

These safety points will be highlighted in a box, like this:

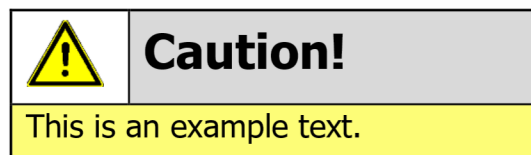

This user manual and the information it contains is only applicable to the model stated on the front cover and must not be used with any other make or model.





Safety Notice! Read before using this product!

Safety Notice - Warning. Ensure power is removed before allowing access to the inside of this product. Ensure any static build up is discharged before allowing access to any part of this product or media contained. Always earth this product/base plate in accordance with the manual.

For use only in or with complete equipment where the acceptability of the combination is determined by UL LLC. When installed in an end-product, consideration must be given to the following:

- The power supply terminals and/or connectors are: Not investigated for field wiring
- The investigated Pollution Degree is: 2
- The following end-product enclosures are required: Mechanical, Fire

Sicherheitshinweis – Warnung: Es muss sichergestellt werden, dass das Gerät von der Versorgungsspannung getrennt wird, bevor ein Eingriff in das Innere des Gerätes erfolgt. Es muss sichergestellt werden, dass jegliche statische Aufladung des Gerätes entladen wird, bevor auf das Gerät oder auf innerhalb des Gerätes befindliche Objekte zugegriffen wird. Die Erdung des Gerätes muss immer gemäß Handbuch erfolgen.

Nur für die Verwendung in oder mit kompletter Ausstattung, dessen Eignung und Kombination von der UL LLC ermittelt wurde. Bei der Installation in einem Endprodukt, muss folgendes berücksichtigt werden:

- Die Spannungsversorgungsklemmen und/oder Verbinder sind: Feldverkabelung wurde nicht untersucht
- Der untersuchte Verschmutzungsgrad ist: 2
- Folgende Anforderungen an die Gehäuse des Endproduktes sind gefordert: Mechanisch, Feuer

Aviso de seguridad: Asegúrese de que la alimentación está desconectada y de que toda la energía estática es descargada antes de manipular este producto. Conecte a tierra la chapa base de la manera que se indica en el manual.

Solo para uso con dispositivos con los cuales la compatibilidad ha sido certificada por UL LLC. Tras su instalación en producto acabado, tener en cuenta lo siguiente:

- Los conectores y terminales de alimentación son: No se ha investigado/especificado cableado externo.
- El grado de contaminación determinado es: 2
- Los siguientes manuales/certificados de producto final son requeridos: Mecánico, Fuego

Avis de sécurité : Assurez-vous que l'alimentation est coupée et que toute l'énergie statique est déchargé avant de manipuler ce produit. Connecter à la terre, la plaque de base à la manière indiquée dans le manuel.

A utiliser Seulement avec les dispositifs dont la compatibilité a été certifiée par UL LLC. Après son installation dans le produit fini, prendre en considération ce qui suit : -

- Les connecteurs et les bornes d'alimentation sont : cela n'a pas été étudié/spécifié câblage externe.
- Le degré de contamination déterminé est: 2
- Les manuels suivants / les certificats du produit final sont nécessaires : mécanique, incendie

Bezpečnostní upozornění. Před manipulací uvnitř tohoto produktu se ujistěte, že je produkt odpojen od zdroje elektrického napětí. Ujistěte se, že jakýkoliv elektrostatický náboj byl vybit před manipulací s jakoukoliv částí tohoto produktu nebo obsaženým médiem. Vždy uzemněte tento produkt/základovou desku v souladu s návodem.

Pouze pro použití v nebo s kompletním vybavením, kde je přijatelnost kombinace určena UL LLC. Při instalaci v konečném produktu je třeba zvážit následující:

- Napájecí svorky a/nebo konektory: Nejsou sledované pro externí kabeláž
- Sledovaný stupeň znečištění je: 2
- Následující krytí konečného produktu jsou požadované: Mechanické, Protipožární



2 PRODUCT INTRODUCTION

2.1 General Description

The NV9 range are versatile banknote validators with cashbox and bezel options to suit all applications, boasting enhanced sensing technology and a high acceptance rate for multi-currency. The units can be mounted horizontally or vertically, and exceptional field reliability make them a truly global product range. A note float module can be added to provide note recycling capability; and on the NV9USB+ a printer module can be added to allow for printing and accepting of tickets.

2.2 Key Features

- Exceptional field reliability
- Enhanced sensing technology
- Cashbox and bezel options to suit all applications
- Future proof
 - Add on recycler available (NV11)
 - Add on printer available (NV12)

2.3 Typical Applications

- Amusement
- Vending

2.4 Component Overview

NV9USB+

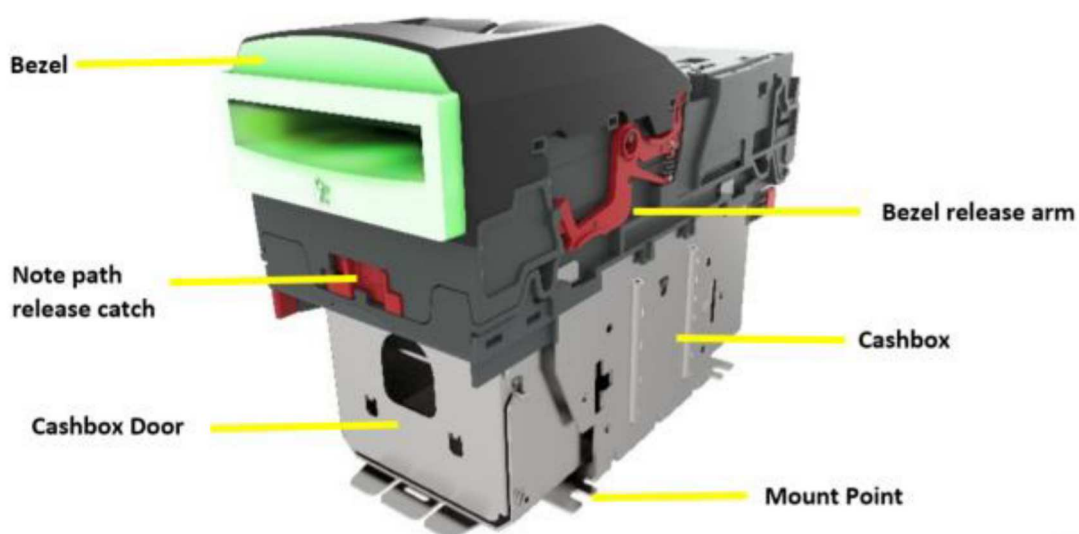

NV11+

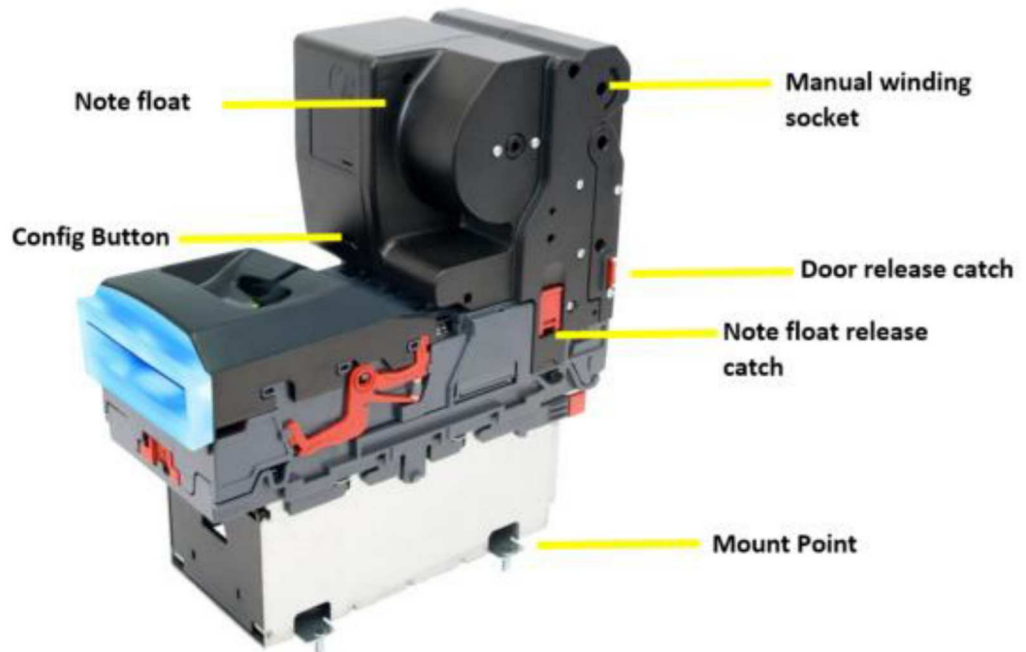

NV12+

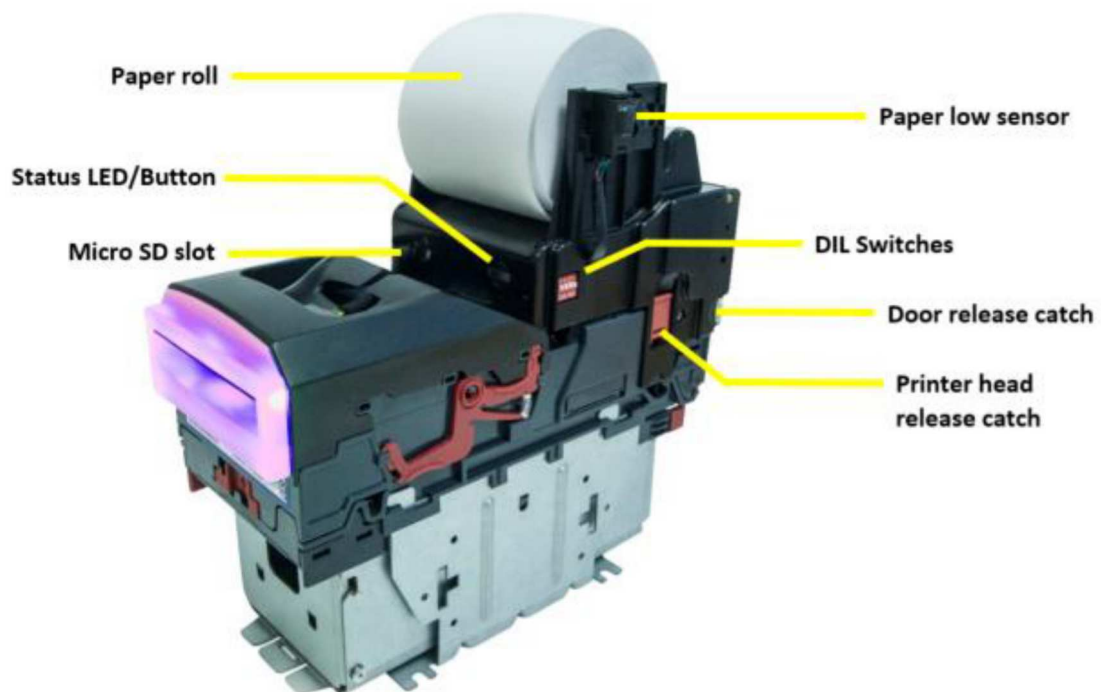

2.5 Bezel Options

ITL Part Number	Description	Details
PA00188	NV9USB+ Vertical Up Bezel (82mm)	http://innovative-technology.com/shop/bezels/nv9-vertical-up-bezel-detail
PA00189	NV9USB+ Standard Horizontal Bezel (82mm)	http://innovative-technology.com/shop/bezels/nv9-standard-horizontal-bezel-detail
PA00190	NV9USB+ Vertical Up Snout Bezel (82mm)	http://innovative-technology.com/shop/bezels/nv9-vertical-up-snout-bezel-detail
PA00191	NV9USB+ Vertical Down Snout Bezel (82mm)	http://innovative-technology.com/shop/bezels/nv9-vertical-down-snout-bezel-detail
PA00268	NV9USB+ Horizontal Bezel (69mm)	http://innovative-technology.com/shop/nv9-anv11-spares/nv9-horizontal-69mm-width-bezel-detail
PA00296	NV9USB+ Vertical Up/Down Flat Bezel (66mm)	http://innovative-technology.com/shop/nv9-anv11-spares/nv9-66mm-vertical-updown-flat-bezel-detail
PA00323	NV9USB+ Vertical Up/Down Flat Bezel (69mm)	http://innovative-technology.com/shop/nv9-anv11-spares/nv9-69mm-width-vertical-updown-flat-bezel-detail
PA00896	NV11 Standard Bezel	http://innovative-technology.com/shop/nv9-anv11-spares/nv11-standard-bezel-detail
PA01144	NV9USB+ Rainbow Bezel (82mm)	http://innovative-technology.com/shop/nv9-anv11-spares/nv9-usb-rainbow-bezel-detail
PA00984	NV9USB+ Facia Short	http://innovative-technology.com/shop/nv9-anv11-spares/nv9-usb-facia-short-detail
PA00985	NV9USB+ Facia Long	http://innovative-technology.com/shop/nv9-anv11-spares/nv9-usb-facia-long-detail
PA02383	NV9USB+ Vertical Rainbow Bezel (69mm)	https://innovative-technology.com/shop/bezels/nv9-usb-vertical-rainbow-bezel-69mm-detail
PA02388	NV9USB+ Vertical Rainbow Bezel (78mm)	https://innovative-technology.com/shop/bezels/nv9-usb-vertical-rainbow-bezel-78mm-detail
PA02568	NV9USB+ Mounting Bracket	https://innovative-technology.com/shop/bezels/nv9-11-12-mounting-bracket-detail



[<< Back to Contents](#)

2.6 Cashbox Options

ITL Part Number	Description	Details
PA00185	NV9USB+ 300 Clip On Cashbox	http://www.innovative-technology.com/shop/bezels/nv9-300-clip-on-cashbox-detail
PA00186	NV9USB+ 300 Lockable Cashbox	http://www.innovative-technology.com/shop/bezels/nv9-300-lockable-cashbox-detail
PA00192	NV9USB+ 300 Slide Cashbox	http://www.innovative-technology.com/shop/bezels/nv9-300-slide-cashbox-detail
PA00193	NV9USB+ 600 Clip on Cashbox	http://innovative-technology.com/shop/nv9-a-nv11-spares/nv9-600-clip-on-cashbox-detail
PA00194	NV9USB+ 600 Slide In Cashbox	http://innovative-technology.com/shop/nv9-a-nv11-spares/nv9-600-slide-in-cashbox-detail
PA00898	NV11 Standard 300 Clip on Cashbox	http://innovative-technology.com/shop/nv9-a-nv11-spares/nv11-standard-cashbox-detail



3 TECHNICAL DATA

3.1 Dimensions

Note: If required, IGES 3D models are available on request from ITL technical support; support@innovative-technology.com

A	300 SLIDE-IN CASH BOX
B	600 SLIDE-IN CASH BOX
C	1000 SLIDE-IN CASH BOX

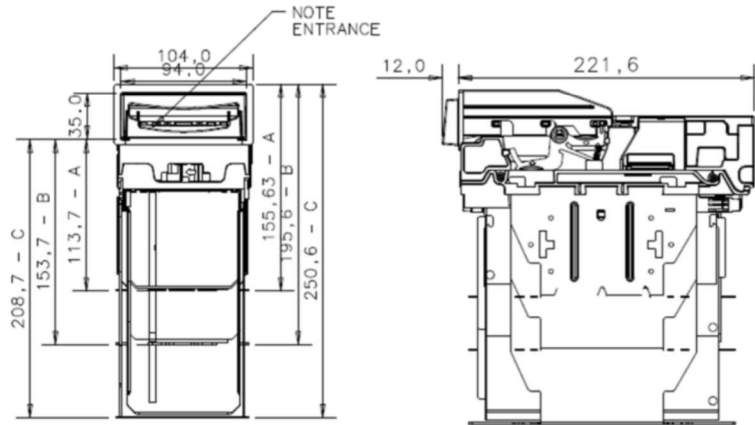

ACCEPTS NOTES UP TO 82mm x 160mm LONG

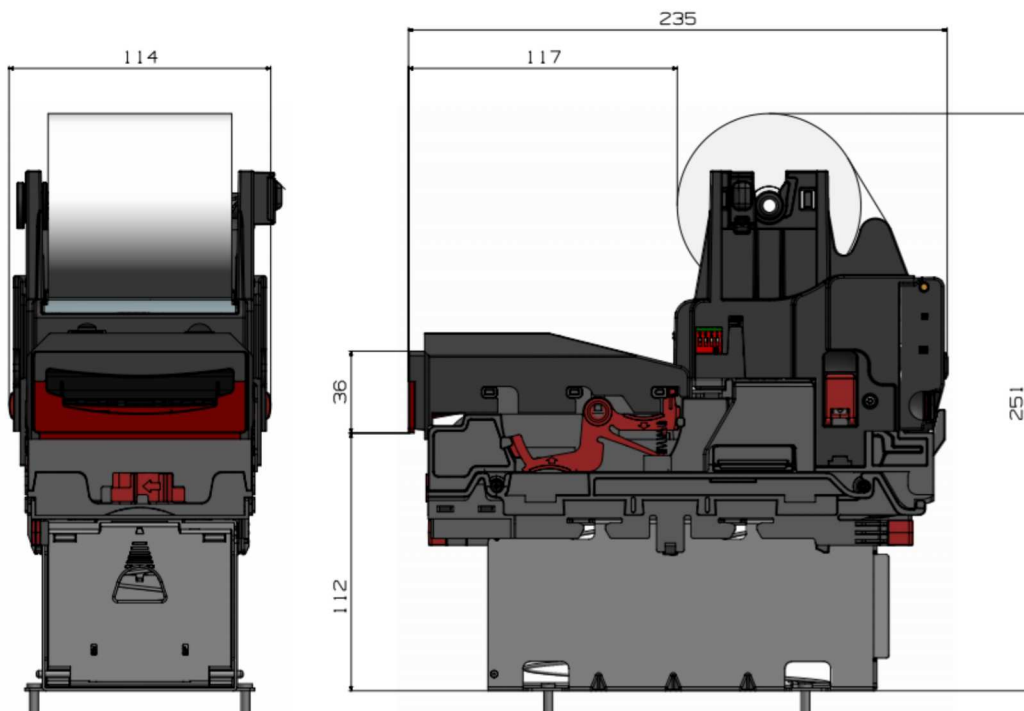
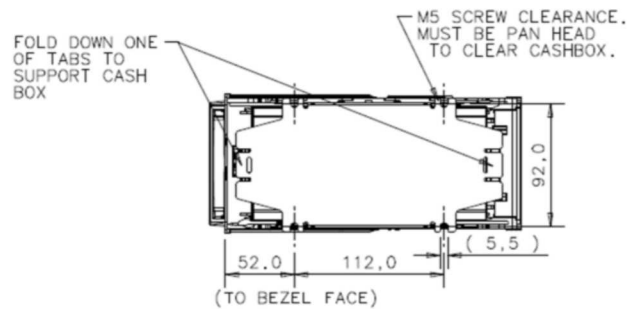

[<< Back to Contents](#)

3.2 Weight(s)

NV9

NV9 300 clip with bezel – 1.41kg

NV9 300 slide with bezel – 1.86kg

NV9 600 clip with bezel – 1.72kg

NV9 600 slide with bezel – 2.14kg

NV11

NV9 300 clip with bezel + note float – 2.22kg

NV12

NV9 300 clip with bezel + NVR-280 printer – 2.2kg

3.3 Environmental Requirements

Environment	Minimum	Maximum
Temperature	+3°C / 37°F	+50°C / 122°F
Humidity	5%	95% non-condensing

3.4 Power Requirements

3.4.1 Supply Voltages

Supply Voltage	Minimum	Nominal	Maximum
Supply Voltage (V DC)	+ 10.8 V DC	+ 12 V DC	+ 14.2 V DC
Supply Voltage (with IF5)	18 V DC	---	48 V DC or 34 V AC
Supply Ripple Voltage	0 V	0 V	0.25 V @ 100 Hz

3.4.2 Supply Currents

NV9USB+

Supply Current	Minimum	Nominal	Maximum
Standby	--	--	0.2 A
Running	--	--	1.0 A
Peak	--	--	1.5 A

NV11+

Supply Current	Minimum	Nominal	Maximum
Standby	--	--	0.35 A
Running	--	--	3.0 A
Peak	--	--	3.5 A



NV12+

Supply Current	Minimum	Nominal	Maximum
Standby	--	--	0.35 A
Running	--	--	2.0 A
Peak	--	--	5.0 A

3.4.3 Power Supply Guidance

The NV9 Range of products require a stable 12V DC power supply. Please check the power requirements of your host machine and other peripherals to dimension a suitable power environment for your machine setup.

TDK Lambda manufactures suitable power supplies. Please see table below for further details.

Power Supply Unit	Specification	RS Stock Code	Farnell Code	Stock	Suitable for use:
TDK Lambda SWS50-12	+12 V DC / 4.3 A	466-5869	1184645		NV9USB+ NV11+
TDK Lambda SWS75-12	+12 V DC / 6.3 A	466-5904	1184648		NV12+

3.5 Interface Logic Levels

Interface Logic Levels	Logic Low	Logic High
Inputs	0V to +0.5V	+3.7V to +12V
Outputs with 2K2Ω pull-up resistor	+0.6V	Pull-up voltage of host interface
Maximum Current Sink	50mA per Output	

3.6 Reliability Data

The below data refers to the Mean Cycles Between Failure (MCBF) and the Mean Cycles Between Intervention (MCBI). The difference between the two is that a failure would usually require the unit being replaced. Whereas an intervention would be an issue that is easily clearable such as a reset or clearing a note path jam.

A cycle is classed as a note or ticket being either accepted or dispensed. For example, if a unit accepts a note and then dispenses a note as change, it is classed as two cycles.

NV9USB+

MCBF: 200,000 Cycles

MCBI: 100,000 Cycles

It is important to note that when adding a recycler or printer, you are doubling the number of modules. Thus, the MCBF/MCBI will naturally be halved.



[<< Back to Contents](#)

NV11+

MCBF: 100,000 Cycles

MCBI: 50,000 Cycles

NV12+

MCBF: 100,000 Cycles

MCBI: 50,000 Cycles

3.7 Media Requirements

3.7.1 Notes

	Minimum	Maximum
Length	90mm	170mm
Width	62mm	82mm

The NV9 range supports multiple currencies and denominations as per the specifications detailed in the table above. Furthermore, polymer and windowed notes are in use in several countries and so are already fully supported on the NV9 range of validators.

3.7.2 Tickets

The NV9USB+ validator is only able to read and accept barcode tickets if the printer module is attached (NV12+). The below information specifies the ticket dimensions as well as the barcode requirements.

3.7.2.1 Ticket Dimensions

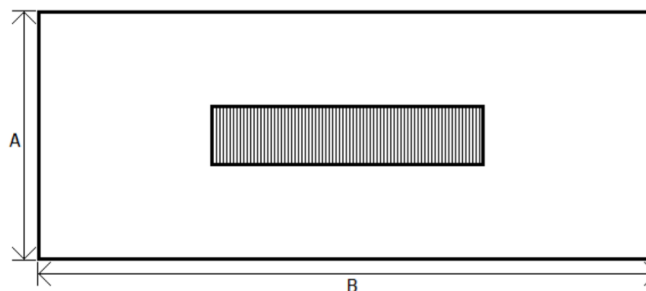

Tickets should have a width (A) of 65mm to 82mm, the smaller the ticket the larger barcode width should be used.



[<< Back to Contents](#)

The length (B) of the ticket is variable, tickets between 90mm and 166mm are acceptable.

3.7.2.2 Barcode Requirements

The interface the validator is operating in will change the possible value of the barcode number.

SSP: Barcode length can be between 6 to 24 characters.

ccTalk: Barcode length is fixed to 18 characters; however, this is configurable.

Dimension

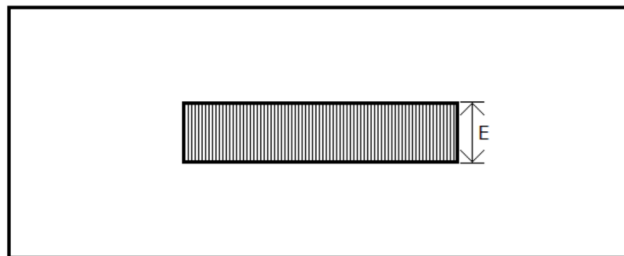

The barcode itself should be no thinner (E) than 10mm. The narrow bar width between 0.5mm and 0.6mm, with the wide narrow ratio (W:N) being 2:1.

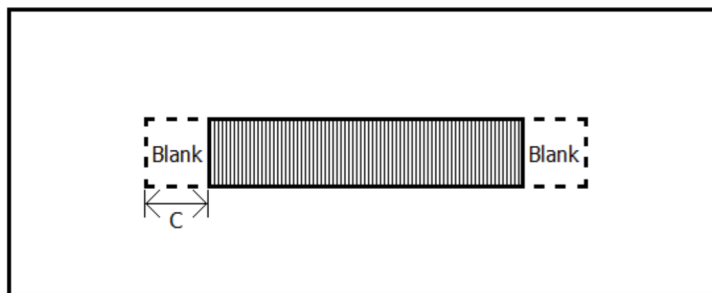

A blank space (C) is required on either side of the barcode as pictures or text may be seen as part of the barcode value.

This space should be 10mm.

Positioning

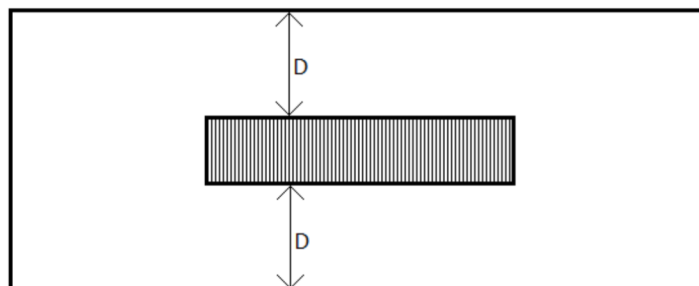

The barcode itself should be centred along the width (D) on the ticket.



[<< Back to Contents](#)

Complete Ticket

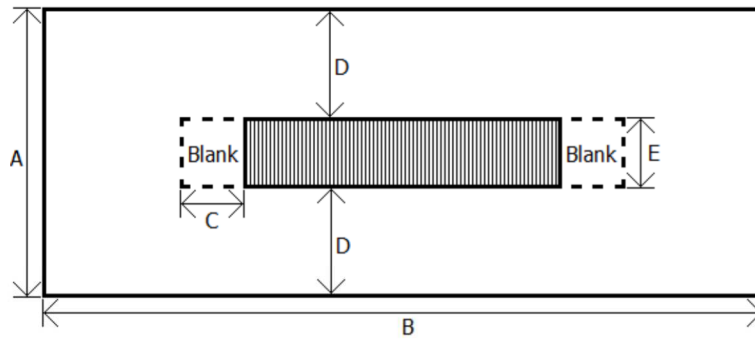

Barcode Characteristic	Details
Narrow Bar Width	Minimum: 0.5mm Maximum: 0.6mm
W: N Ratio	2:1
Number of Characters	Minimum: 6 Maximum: 24

Dimension	Details
A	65mm to 82mm
B	90mm to 166mm
C	Minimum 10mm
D	Barcode must be centered
E	Minimum 10mm



4 MECHANICAL INSTALLATION

4.1 Compatibility

4.1.1 Hardware Compatibility

4.1.1.1 Machine Mounting

Assuming the suitable bezel (and cashbox) type has been ordered the NV9USB range can be used as fitting replacement for the following products:

- NV7
- NV7M
- NV9

Please note: Considerations will need to be made when adding either the recycler or printer module, as this will increase the space requirements inside the host machine.

The NV11+ and NV12+ have the same space envelope so swapping the recycler for the printer will not require any mechanical adjustments.

Innovative Technology Ltd. has a policy of continuous product improvement. Due to design changes, older model, or product bezels (and cashboxes) may not be compatible with the current NV9USB+. However, new product deliveries always include a bezel (and cashbox) that must be used.

4.1.1.2 Machine Interfacing

By design the NV9USB+ and NV11+ are pin to pin compatible with the fitting replacement products listed above. No changes to existing machine harnessing are required.

The NV12+ has an additional connector to power and communicate with the printer head.

Pin	Description
1	0V
2	RS232 Data in (RX)
3	TTL Data in (RX)
4	+12V
5	RS232 Data Out (TX)
6	TTL Data Out (TX)

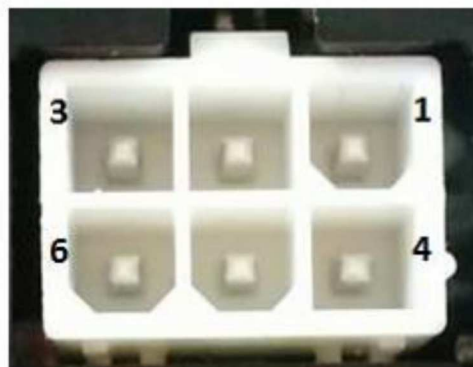

[<< Back to Contents](#)

4.1.1.3 Power Supply

It is vital that the product is connected to a power supply being able to provide the required power environment. A weak power supply can lead to unexpected behaviour such as note rejects or missing credits. If you are replacing an older model or product, we recommend checking the power supply specifications of the machine. The newer models might have higher power consumption. Refer to [3.4](#) for full power requirement details of the full NV9 range.

4.1.2 Software Compatibility

4.1.2.1 Interface Protocols

When using the NV9 range of products as a fitting replacement for an older model or product some events such like credits may be given earlier. This is due to improved firmware routines and faster motors being used. This may cause missing events such like credits in those host machines where timeouts are defined for the older model or product. Please contact the machine manufacturer for full compatibility.

4.1.2.2 Re-programming

For re-programming the units always use the latest version of Validator Manager, available for download from our website. Newer products may not be fully supported on older versions of Validator Manager. For further details on Re-programming, refer to [5.4](#).



4.2 Bezel Mounting

4.2.1 Bezel Fitting

1. Locator lugs

Place bezel down onto validator, ensuring locating lugs go into spaces provided (1).

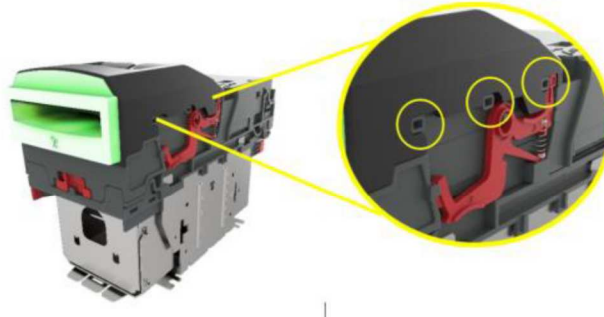

2. Lock bezel in place

Slide bezel backwards until you hear release latch arm, click into place.



4.2.2 Bezel Removal

1. Release clips

Pull release clip upwards (1)
With release clip held upwards, you can pull bezel towards front of unit (2).



2. Lift Bezel

Now bezel is free of locating lugs, lift bezel upwards (3).

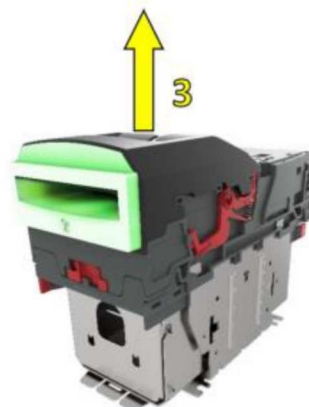

4.3 Cashbox Mounting

Below you will find details on how to fit the different cashboxes mentioned in [section 2.6](#).

Slide cashboxes are made up of 2 x parts. The outer housing and the cashbox itself, which slides in and out of the housing. These are used for when the unit is mounted horizontally.

Clip on cashboxes attach directly onto the validator. These are mainly used for when the unit is mounted vertically.

4.3.1 Cashbox Fitting

1. Slide Cashbox

The outer housing has 2 x lugs on either side and these need to be pushed up into the cashbox slots as per the image.

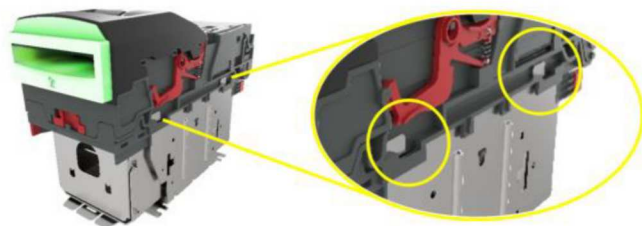

Then slide housing forwards to lock into place.

The outer housing is mounted inside the machine, and you simply slide the removable cashbox, inside the outer housing.

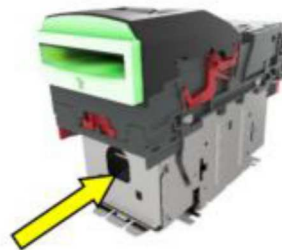

2. Clip-on Cashbox

The clip-on cashbox attaches directly to the validator and is identical to the process above.

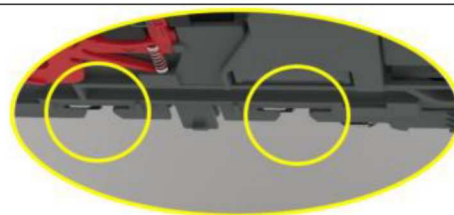

To improve the fixation of the cashbox is recommended bending the fixing tab to prevent it from falling when handling the validator.



4.3.2 Cashbox Removal

1. Slide Cashbox

Remove the cashbox from the outer housing.

Pull cashbox release catch away from validator and slide cashbox out.

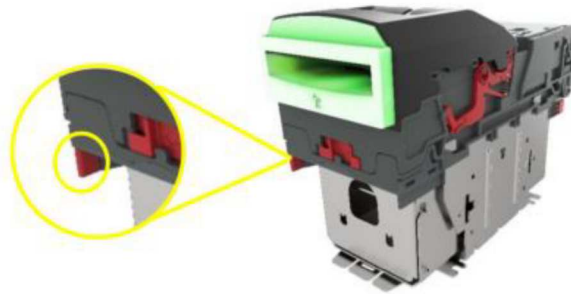

Push the tab (1) seen in the image whilst sliding the outer housing back, so that the locating tabs are free to move away from the validator.

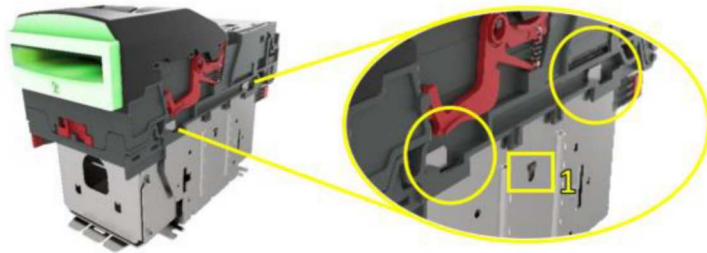

2. Clip-on Cashbox

Simply slide the cashbox back so that the locating tabs are no longer locked in position. You can then pull cashbox away from unit.

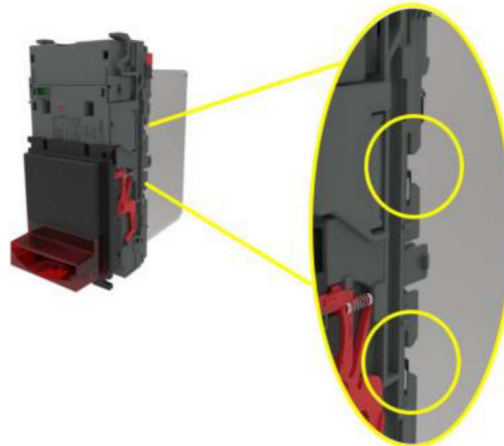

4.4 Lock Mounting

The NV9 range has an option for a 300-lockable cashbox. This is designed for a 300-**slide** cashbox option.

ITL Part Number: PA00186

Web shop link: <https://innovative-technology.com/shop/nv9-a-nv11-spares/nv9-300-lockable-cashbox-detail>

Details on the locking position can be found below.

4.4.1 Lock Fitting

1. Screw Holes

The lockable door attaches to the cashbox housing via 3 x screw holes, as shown.

These can be found on all 4 x sides of the cashbox.
Front Right; Front left
Back right, back let.

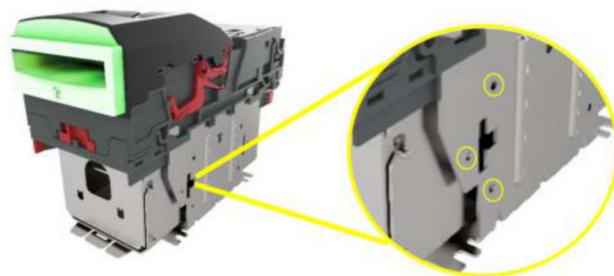

2. Locking Cam Slot

You'll also see 4 x slots for each position too. This is where the lock slides into, to lock the door in place.

Please note you want to use the 3 x mounting screw points, on the opposite side of where your lock will be.

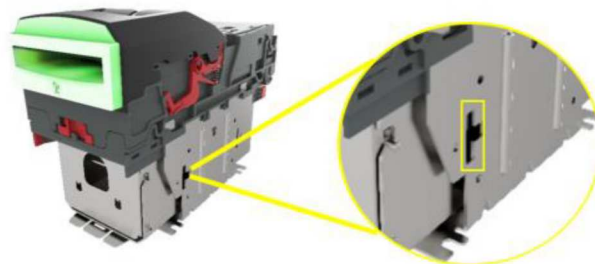

For example: if you want the lock to be Front Right – you'd mount the door on the front left. So that the door swings round and locks on the side you specified.

3. Lock

Using front right as an example, this specifies the location of the lock (2). In this case, the door is mounted as seen (1).

Lock specification details can be found below in [section 4.4.2](#).



[<< Back to Contents](#)

4.4.2 Lock Specifications

Locks for the NV9 range cashbox are available from Innovative Technology Ltd.

ITL Part Number: PA00650

Web shop Link: <http://innovative-technology.com/shop/nv200-spares/lock-detail>

Please note: PA00650 is a universal lock across a number of our products therefore the website may stock it under a different product's spare list.

However, there are various lock manufacturers and distributors. Refer to [Appendix 11.3](#) for lock specification.

4.4.3 Lock Cam

The following Lock Cam needs to be ordered from Innovative Technology Ltd. additionally to the lock for full locking capability.

ITL Part Number: MC00186

Web shop Link: <https://innovative-technology.com/shop/nv9-a-nv11-spares/locking-cam2013-10-14-08-48-365-detail>



4.5 Machine Mounting

4.5.1 Machine Mounting

1. Horizontal Configuration

The slide cashbox configuration has 4 x mounting points, for each corner.

These should be used to secure the validator to a base/shelf inside the host machine.

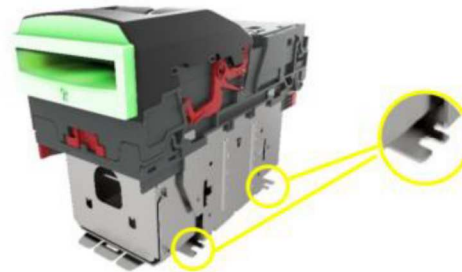

2. Vertical Configuration

The vertical bezels available to the NV9 range all have mounting locations to allow you to mount the unit to the back of the door.

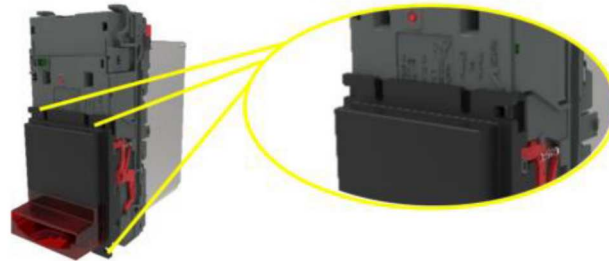

4.5.2 Earth Bonding

It is very important that the NV9USB+ is properly bonded to earth. Lack of proper bonding can cause communication issues and other failures.

5 SOFTWARE INSTALLATION AND CONFIGURATION

5.1 Introduction

The NV9USB+, NV11+ and NV12+ all leave the factory pre-programmed with dataset and firmware files. However, it is important to ensure your device is kept up to date with the latest dataset and firmware. This section will give you a brief overview of the various update possibilities. For detailed instructions please refer to the relevant manual package supplied with the software or contact support@innovative-technology.com.

5.2 Software Downloads

All software from Innovative Technology Ltd is free of charge and can be downloaded from the website www.innovative-technology.com/support/secure-download once registered and logged in. If you are not registered, please create an account via the Create an account form. A confirmation email will be sent to the registered email address once all contact details have been successfully submitted.

5.3 Drivers

The ITL drivers allow you to connect any of our validators to a compatible Windows device. If you are connecting via an IF17 then you will not need to follow this process as they are signed Microsoft Drivers and should install automatically. If this isn't the case or your computer is disconnected from the network, there is a standalone package included within the driver downloads.

5.4 Dataset/Firmware Programming

5.4.1 Validator Manager

5.4.1.1 General Description

Validator Manager is a utility which allows the user to reprogram any of ITL's validators. Please note that admin rights are required during installation. The validator must be in SSP for the Validator Manager to detect the device.

5.4.1.2 System Requirements

- Windows 7 or above
- .Net Framework 4
- 256mb ram
- 50mb hard disk free
- Connected validator with active com port



	Caution!
We have seen instances where one of the DLL (itdata1.dll) used in Validator Manager are flagged as a Trojan, this is a false positive and if this happens you will need to add a rule to your antivirus to allow the file to run.	

5.4.1.3 Hardware Setup

IF17 Kit:

Connect the power supply to the IF17 and the USB cable to the IF17 to your host machine. Connect the Ribbon cable from the IF17 to the validator.

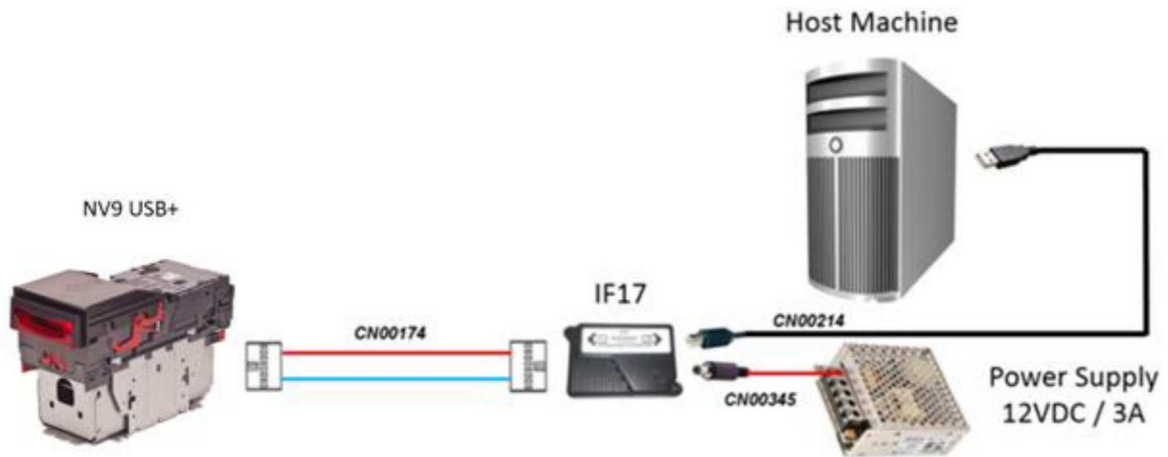

Direct USB:

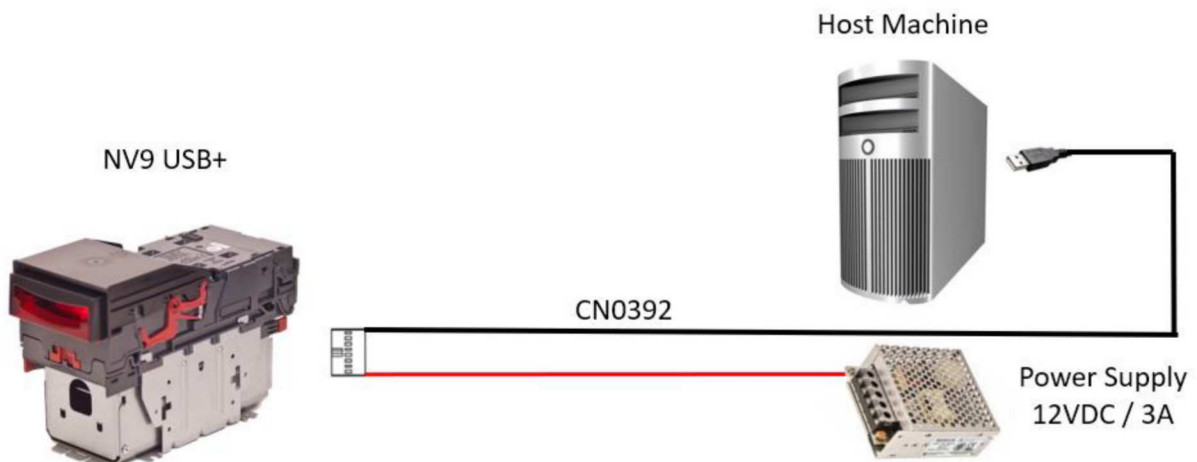

Please note: the connection methods are identical between NV9 and NV11 products.



[<< Back to Contents](#)

NV12:

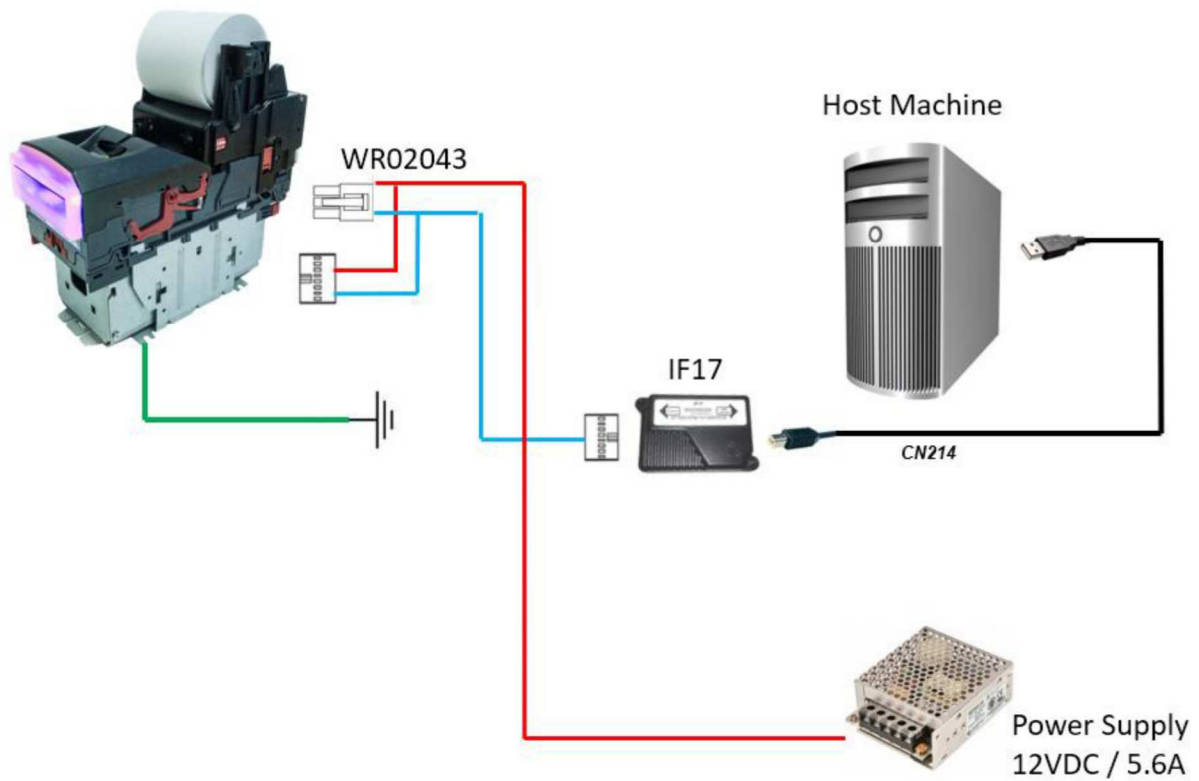

5.4.1.4 Switching to Programming Mode (SSP)

Before programming via Validator Manager, the device needs to be switched to its programming mode (SSP interface). Please refer to [Appendix 11.5](#) for the procedure for doing this.

5.4.1.5 Programming the device

Once you have switched the unit into SSP, open Validator Manager and click detect devices. This will scan all active com ports for a unit, if your validator fails to connect, please ensure the correct drivers are installed and the unit is in SSP.

By selecting the Program tab, you can reprogram the validator. To begin the upload, click open file, then browse to the file location before clicking OK.



[<< Back to Contents](#)

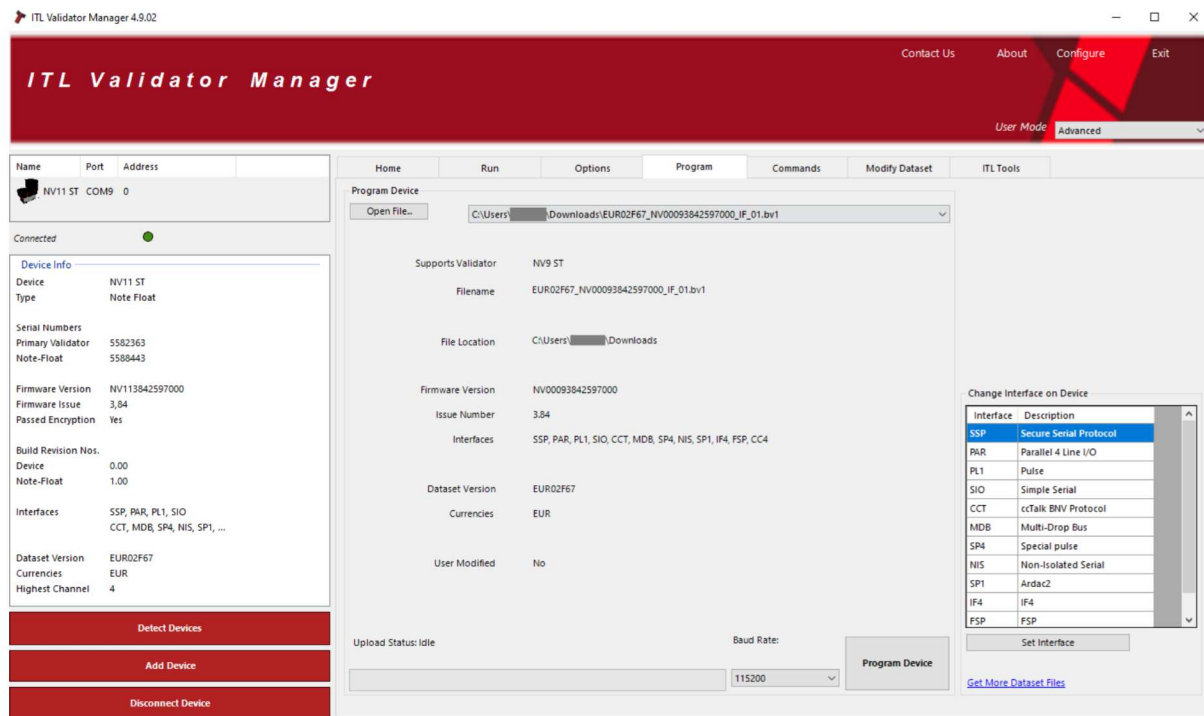

Once the file has been selected its information will be populated and the Program device tab will become active. Finally hit 'Program Device', the unit's bezel will now begin to flash signaling the update has begun.

	<h2>Caution!</h2>
<p>Interrupting the download process can result in the unit entering a non-functional state, once the process has started it cannot be halted.</p>	

When completed the unit will restart and a pop-up box will appear saying "Device Programming Complete".

5.4.2 DA3

5.4.2.1 General Description

The DA3 is a hand-held validator programming system that enables the user to re-program ITL banknote validators in the field, without the use of a PC. Dataset and firmware files for different validator models can be stored on the DA3. Once programmed the user can update or override existing software as well as test the functionality of the validator, away from the host machine.



5.4.2.2 System Requirements

- Windows XP SP3 or above
- .Net Framework 4
- 256mb ram
- 50mb hard disk free
- Connected DA3 with active com port
- Data Flash Card (PA01121) **optional**

5.4.2.3 Re-programming via DA3

To program using the DA3 programmer, you first need to load the DA3 with the necessary files. You will need to use one of our software tools, Device Programming System (DPS) which can be downloaded from our website.

For information on programming the DA3, you can refer to our Software Manual – GA02037.



Once the files are loaded onto the DA3, the validator can be updated. Simply remove the host machine cable and plug this into the “Host machine” port on the DA3 as shown in the image above. You will then need a ribbon cable to connect the DA3 to the validator itself, via the “validator” port. The DA3 should now be sat in-line between host and validator, with the DA3 being powered from the host connector.

Now ensure that the unit is in SSP (programming mode - see [appendix 11.5](#)) and on the front side of the DA3, use the mode select button to choose either BNV Match Download or BNV Override download – based on how you set the DA3 up – and simply press the large play button in the middle. Once the download has begun, you will see the blue LED’s start to swirl and will continue to do so until download is complete.

[<< Back to Contents](#)

The play button will turn **GREEN** if the download has been completed successfully. If for whatever reason there is an error, the play button will turn **RED**, and the download method LED will be flashing an error code for further diagnosing. A table of error codes can be found below:

1 Long flash followed by

Number of SHORT flashes	Indicated Status / Error
2	No validator connection found
3	No valid download files found
4	Download fail
5	Memory card fail

5.4.2.4 SMART Update DA3

The DA3 also has a feature called SMART Update, which provides all applicable dataset files for a given currency across our entire product range, into a single file.

Differences from standard DA3:

- SMART Update firmware required on DA3
- SD card with download file, inserted into slot A
- SMART Update method only updates the file on the validator, no settings can be changed.

Our complete SMART Update package, along with full information guide can be downloaded from our software section on our website.

5.4.3 Remote Updates

5.4.3.1 General Description

The NV9 range of products all support remote update, which is the ability to send an update file via protocol commands. This means that you do not physically have to be stood at the machine, as the host initiates the download via the protocol.

5.4.3.2 Software Requirements

Remote update relies on a series of packets to be transmitted to the validator and thus only the serial protocols such as SSP and ccTalk allow this feature.

Details of how this is implemented can be found in our SSP implementation guide (GA00973).

You will have to check with the machine manufacturer as to whether this is a feature their software supports.



5.4.4 Configuration Card

5.4.4.1 General Description

Configuration cards can be used as a quick and simple way of changing certain options just by inserting the paper into the bezel mouth.

An example of the configuration card can be found below, with a full print out version and instructions in [Appendix 11.11](#).

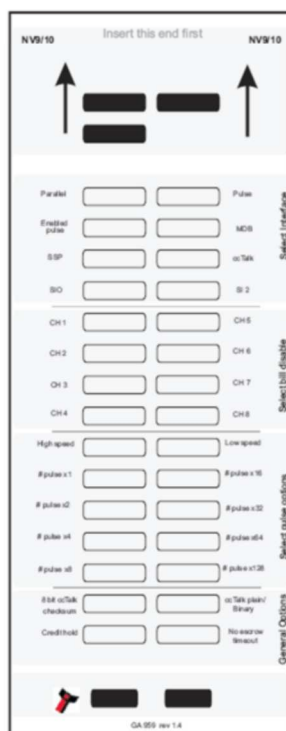

Please note: This feature is not available on the UK special version of firmware.

5.4.4.2 Hardware Requirements

- GA00959 – Configuration card
 - Printed, cut to size, and filled in as required.
- NV9USB or later model

5.4.4.3 Re-programming via Configuration Card

Re-programming the validator simply requires the relevant fields on the card are filled in with solid black ink, the unit to be in config card mode and then inserting the card into the bezel mouth, as you would a note.

Full instructions on programming via the configuration card can be found in [Appendix 11.11](#)



6 PROTOCOLS AND INTERFACING

6.1 Introduction

The NV9 range supports standard industry protocols. Interfaces that are not listed may be available upon request. For any queries regarding interfaces that are not listed please contact support@innovative-technology.com.

	Caution!
The use of an encrypted protocol (preferable eSSP) is strongly recommended to achieve the highest security.	

6.2 SSP and eSSP

6.2.1 General Description

Smiley® Secure Protocol (SSP) and Encrypted Smiley® Secure Protocol (eSSP) are field proven secure interfaces specifically designed by Innovative Technology Ltd. to address the problems by cash handling systems in gaming machines. Problems such as acceptor swapping, re-programming acceptors and line tapping are all addressed. This interface is recommended for all new designs. Innovative Technology Ltd. provides full SDK packages upon request including Interface Specification, Implementation Guide as well as source code examples for C++, C#.NET and Linux. Please contact support@innovative-technology.com for further information.

6.2.2 Pin Assignments



Pin	Name	Type	Description
1	Vend 1	Output	Serial Data Out (Tx)
2	Vend 2	Output	DA3 Data Logging
3	Vend 3	Output	Not Used
4	Vend 4	Output	Not Used
5	Inhibit 1	Input	Serial Data In (Rx)



<< [Back to Contents](#)

6	Inhibit 2	Input	Not Used
7	Inhibit 3	Input	Not Used
8	Inhibit 4	Input	Not Used
9	Busy	Output	Not Used
10	Escrow	Input	Not Used
11	USB +	Data	USB Data +
12	USB -	Data	USB Data -
13	USB Vcc	Power	USB Vcc (+5VDC)
14	Factory Use Only		Do not connect
15	+ Vin	Power	+12/24VDC Supply
16	0V	Power	0V Supply (GND)

	Caution!
+12VDC and 0V (GND) must always be connected, also when using USB connections.	

6.2.3 Setup Examples

The drawings below highlight how to connect the NV9 range to an SSP or eSSP host machine using available cables and interfaces from Innovative Technology Ltd. For cable drawings please refer to [Appendix 11.1](#).

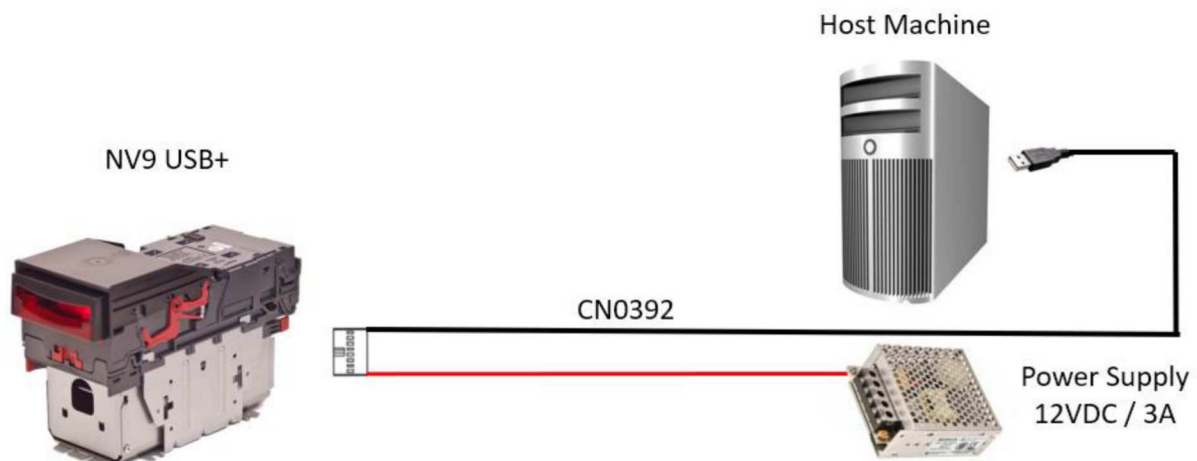

Type	ITL Part Number	Description	Details
Cable	CN00392	Validator to USB Cable	http://www.innovative-technology.com/de/shop/cables/nv9-nv10-usb-host-cable-detail



<< Back to Contents

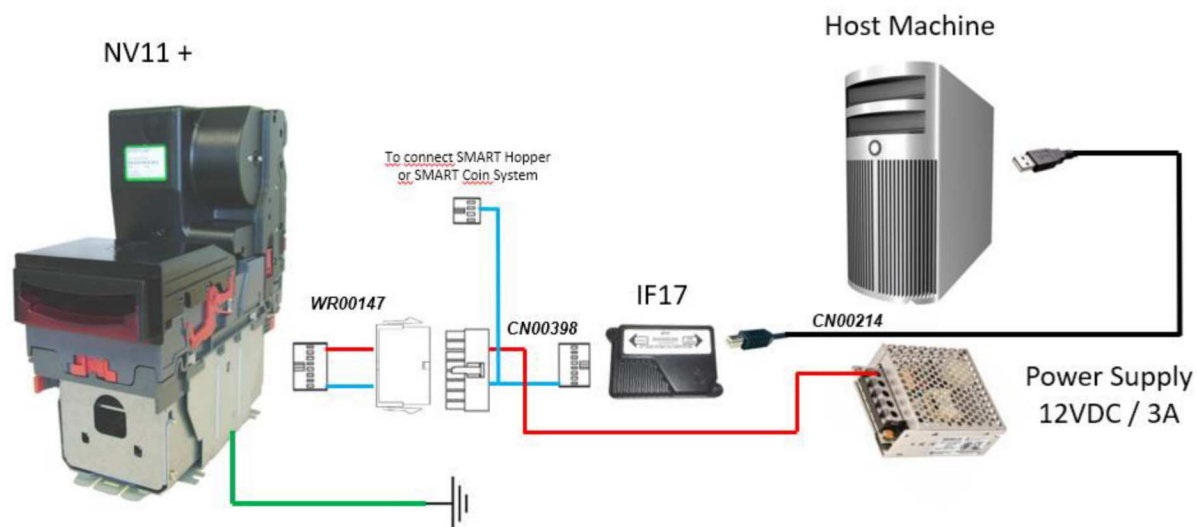

Type	ITL Part Number	Description	Details
Cable	CN00398	Dual SSP Interface Cable	http://www.innovative-technology.com/shop/cables/dual-essp-interface-for-smart-hopper-a-smart-payout-detail
Cable	WR00147	SMART Payout to NV200 Adapter	http://www.innovative-technology.com/shop/cables/smart-payout-to-nv200-adaptor-detail
Cable	CN00214	USB Type A to B	http://www.innovative-technology.com/shop/cables/usb-a-to-b-cable-assembly-detail
Interface	IF17 (PA01081)	TTL to USB Converter	http://www.innovative-technology.com/shop/accessories/if17-interface-converter-detail



<< Back to Contents

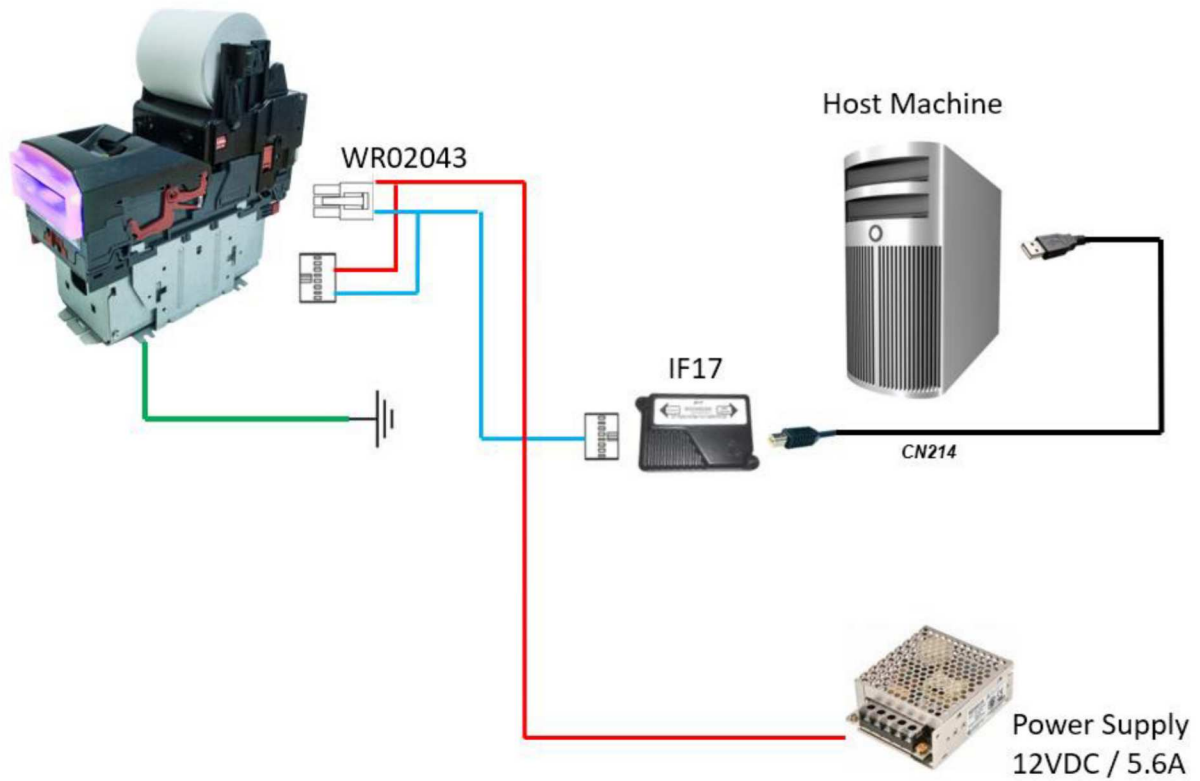

Type	ITL Part Number	Description	Details
Cable	WR02043	NVR-280 Cable	http://innovative-technology.com/shop/cables/nvr280-cable-detail
Cable	CN00214	USB Type A to B	http://www.innovative-technology.com/shop/cables/usb-a-to-b-cable-assembly-detail
Interface	IF17 (PA01081)	TTL to USB Converter	http://www.innovative-technology.com/shop/accessories/if17-interface-converter-detail



6.3 ccTalk®

6.3.1 General Description

ccTalk® is a serial communications protocol designed by Money Controls to allow 3-wire interfacing between a host and cash handling peripherals. Please contact support@innovative-technology.com for further information.

6.3.2 Pin Assignments

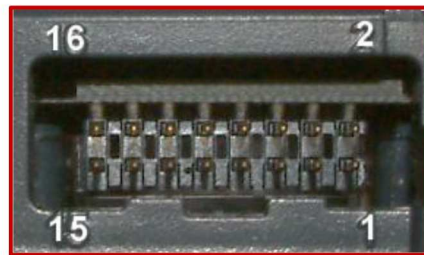

Pin	Name	Type	Description
1	Vend 1	Output	Serial Data (link to Pin 5)
2	Vend 2	Output	DA3 Data Logging
3	Vend 3	Output	Not Used
4	Vend 4	Output	Not Used
5	Inhibit 1	Input	Serial Data (link to Pin 1)
6	Inhibit 2	Input	Not Used
7	Inhibit 3	Input	Not Used
8	Inhibit 4	Input	Not Used
9	Busy	Output	Not Used
10	Escrow	Input	Not Used
11	USB +	Data	USB Data +
12	USB -	Data	USB Data -
13	USB Vcc	Power	USB Vcc (+5VDC)
14	Factory Use Only		Do not connect
15	+ Vin	Power	+12/24VDC Supply
16	0V	Power	0V Supply (GND)



Caution!

+12VDC and 0V (GND) must always be connected, also when using USB connections.

[<< Back to Contents](#)

6.3.3 ccTalk® DES Encryption

When using ccTalk® DES encryption, the validator and host machine must exchange a secret key which forms the basis of the communication encryption. This exchange is performed in a Trusted Mode maintaining security. The Trusted Mode can only be entered by a physical access to the validator. Please refer to [Appendix 11.6](#) for details.



6.4 CC4

6.4.1 General Description

The CC4 protocol is an extension of ccTalk with additional status and payout commands to support the note float recycler unit and thus should be used if wanting to use the NV11 in ccTalk. Please contact support for the necessary protocol documentation.

6.4.2 Pinout

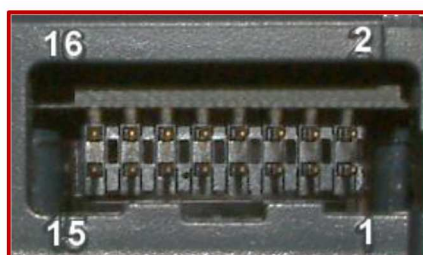

Pin	Name	Type	Description
1	Vend 1	Output	Serial Data (link to Pin 5)
2	Vend 2	Output	DA3 Data Logging
3	Vend 3	Output	Not Used
4	Vend 4	Output	Not Used
5	Inhibit 1	Input	Serial Data (link to Pin 1)
6	Inhibit 2	Input	Not Used
7	Inhibit 3	Input	Not Used
8	Inhibit 4	Input	Not Used
9	Busy	Output	Not Used
10	Escrow	Input	Not Used
11	USB +	Data	USB Data +
12	USB -	Data	USB Data -
13	USB Vcc	Power	USB Vcc (+5VDC)
14	Factory Use Only		Do not connect
15	+ Vin	Power	+12/24VDC Supply
16	0V	Power	0V Supply (GND)



Caution!

+12VDC and 0V (GND) must always be connected, also when using USB connections.

6.5 SIO and SI2

6.5.1 General Description

SIO (Serial Input/Output) is a very basic and low level serial communication interface. Messages are not echoed back. SIO uses 300 baud whereby SI2 uses 9600 baud. Please contact support@innovative-technology.com for SIO Interface Specification or other details.

	Caution!
SIO and SI2 are outmoded and not recommended for new developments!	

6.5.2 Pinout



Pin	Name	Type	Description
1	Vend 1	Output	Serial Data Out (Tx)
2	Vend 2	Output	DA3 Data Logging
3	Vend 3	Output	Not Used
4	Vend 4	Output	Not Used
5	Inhibit 1	Input	Serial Data In (Rx)
6	Inhibit 2	Input	Not Used
7	Inhibit 3	Input	Not Used
8	Inhibit 4	Input	Not Used
9	Busy	Output	Not Used
10	Escrow	Input	Not Used
11	USB +	Data	USB Data +
12	USB -	Data	USB Data -
13	USB Vcc	Power	USB Vcc (+5VDC)
14	Factory Use Only		Do not connect
15	+ Vin	Power	+12/24VDC Supply
16	0V	Power	0V Supply (GND)



6.6 MDB

6.6.1 General Description

MDB (Multi-Drop Bus) is used in the vending industry and is now an open standard in the NAMA (National Automatic Merchandising Association) so that all vending and peripheral equipment communicates identically. MDB uses a master-slave model where the VMC (Vending Mechanism Controller) is the master that can communicate with up to 32 slaves (e.g., banknote validator or coin acceptor). Please contact support@innovative-technology.com for further information.

6.6.2 IF5 Interface

An NV9USB+ running MDB can use an IF5, an external interface box, which regulates the power supply and opto-isolates the communication lines. Typically vending machine's power supply higher voltage than the maximum for the NV9USB+ of 12V +/- 10%. The IF5 drops this higher voltage down to the required level.



6.7 Parallel

6.7.1 General Description

Parallel is a 4-way output interface. The first 4 channels have their own individual output which means that only a maximum of 4 channels can be used. If a note is recognised the relevant Vend line is set to low for a period of $100 \pm 3\text{ms}$. Pulses outside these limits should be rejected as a precaution against false triggering.

	Caution!
Parallel is an unsecure interface and should not be used for new developments!	

6.7.2 Pinout

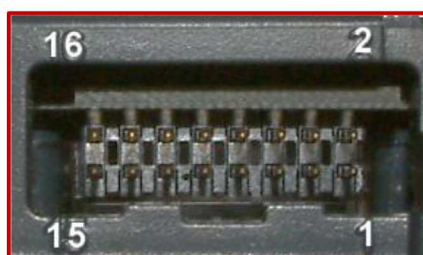

Pin	Name	Type	Description
1	Vend 1	Output	Credit Output Channel 1
2	Vend 2	Output	Credit Output Channel 2
3	Vend 3	Output	Credit Output Channel 3
4	Vend 4	Output	Credit Output Channel 4
5	Inhibit 1	Input	Inhibit Input Channel 1
6	Inhibit 2	Input	Inhibit Input Channel 2
7	Inhibit 3	Input	Inhibit Input Channel 3
8	Inhibit 4	Input	Inhibit Input Channel 4
9	Busy	Output	Output Busy Signal
10	Escrow	Input	Input Escrow Control
11	USB +	Data	Not Used
12	USB -	Data	Not Used
13	USB Vcc	Power	Not Used
14	Factory Use Only		Do not connect
15	+ Vin	Power	+12VDC Supply
16	0V	Power	0V Supply (GND)



6.7.3 Inhibit Control

The Inhibits can be used to either enable or disable the acceptance of those banknotes programmed on channels 1, 2, 3 and 4. The Inhibits are internally held high and must be set to low (GND) to enable banknote acceptance. If no Inhibit is set to low (GND) the Master Inhibit is set and the validator is disabled.

6.7.4 Escrow Control

The NV9 validator has a single note escrow facility. This allows the unit to hold onto the note once validated, and then only stack the note into a cashbox when the host machine confirms that the Vend operation has been completed. Please refer to [Appendix 11.8](#) for timing diagram and further details.

6.7.5 IF10 Interface

The IF10 is an interface that allows serial SSP to be used in machines without the need of updating the machine software. The IF10 is connected between the validator and the host machine. The IF10 communicates with the validator in serial SSP which gives more security along the length of the cable. The IF10 should be mounted close to the host machine control board where the IF10 converts to the parallel connection.



6.8 Binary

6.8.1 General Description

If the machine needs more than 4 denominations to be recognised but the host machine cannot take advantage of the serial communication method, then the NV9USB+ validator can be set to give a binary pattern output on the four parallel output pins. If the validator is set to Binary, it will issue the vend signals as a binary pattern on the parallel outputs for 100 ± 3 ms. In this way a maximum of 15 different notes can be accepted and 4 notes individually inhibited.

The four channels have their own individual outputs. If a note is recognized the binary representation of the channel number will be pulled low for 100 ± 3 ms. Pulses outside these limits will be rejected as a precaution against false triggering due to noise.

For example, if a note programmed on channel 3 is credited, vend 1 ($2^0 = 1$ decimal) and vend 2 ($2^1 = 2$ decimal) will be active low for 100 ± 3 ms.

	Caution!
Binary is an unsecure interface and should not be used for new developments!	

6.8.2 Pinout



Pin	Name	Type	Description
1	Vend 1	Output	Credit Output binary $2^0 = 1$ decimal
2	Vend 2	Output	Credit Output binary $2^1 = 2$ decimal
3	Vend 3	Output	Credit Output binary $2^2 = 4$ decimal
4	Vend 4	Output	Credit Output binary $2^3 = 8$ decimal
5	Inhibit 1	Input	Inhibit Input Channel 1
6	Inhibit 2	Input	Inhibit Input Channel 2
7	Inhibit 3	Input	Inhibit Input Channel 3
8	Inhibit 4	Input	Inhibit Input Channel 4
9	Busy	Output	Output Busy Signal
10	Escrow	Input	Input Escrow Control
11	USB +	Data	Not Used



[<< Back to Contents](#)

12	USB -	Data	Not Used
13	USB Vcc	Power	Not Used
14	Factory Use Only		Do not connect
15	+ Vin	Power	+12VDC Supply
16	0V	Power	0V Supply (GND)

6.8.3 Inhibit Control

The Inhibits can be used to either enable or disable the acceptance of those banknotes programmed on channels 1, 2, 3 and 4. The Inhibits are internally held high and must be set to low (GND) to enable banknote acceptance. If no Inhibit is set to low (GND) the Master Inhibit is set and the validator is disabled.

6.8.4 Escrow Control

The NV9 validator has a single note escrow facility. This allows the unit to hold onto the note once validated, and then only stack the note into a cashbox when the host machine confirms that the Vend operation has been completed. Please refer to [Appendix 11.8](#) for timing diagram and further details.

6.8.5 IF9 Interface

The IF9 is an interface that allows serial SSP to be used in machines without the need of updating the machine software. The IF9 is connected between the validator and the host machine. The IF9 communicates with the unit in serial SSP which gives more security along the length of the cable. The IF9 should be mounted close to the host machine control board where the IF9 converts to the binary connection.



6.9 Pulse

6.9.1 General Description

Pulse can be used for the acceptance of up to 16 channels. When a note is recognised vend 1 (pin 1) will pulse a pre-set number of times. The number of pulses as well as the high/low pulse ratio is configurable. For programming and configuration please refer to [Section 4](#) of this User Manual.

	Caution!
Pulse is an unsecure interface and should not be used for new developments!	

6.9.2 Pinout

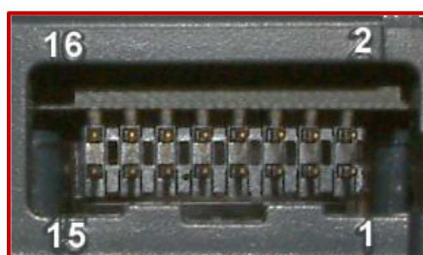

Pin	Name	Type	Description
1	Vend 1	Output	Credit Output Pulse Stream
2	Vend 2	Output	Not Used
3	Vend 3	Output	Not Used
4	Vend 4	Output	Not Used
5	Inhibit 1	Input	Inhibit Input Channel 1
6	Inhibit 2	Input	Inhibit Input Channel 2
7	Inhibit 3	Input	Inhibit Input Channel 3
8	Inhibit 4	Input	Inhibit Input Channel 4
9	Busy	Output	Output Busy Signal
10	Escrow	Input	Input Escrow Control
11	USB +	Data	Not Used
12	USB -	Data	Not Used
13	USB Vcc	Power	Not Used
14	Factory Use Only		Do not connect
15	+ Vin	Power	+12VDC Supply
16	0V	Power	0V Supply (GND)



6.9.3 Inhibit Control

The Inhibits can be used to either enable or disable the acceptance of those banknotes programmed on channels 1, 2, 3 and 4. The Inhibits are internally held high and must be set to low (GND) to enable banknote acceptance. If no Inhibit is set to low (GND) the Master Inhibit is set and the validator is disabled.

6.9.4 Escrow Control

The NV9 validator has a single note escrow facility. This allows the unit to hold onto the note once validated, and then only stack the note into a cashbox when the host machine confirms that the Vend operation has been completed. Please refer to [Appendix 11.8](#) for timing diagram and further details.

6.9.5 Credit Hold Function

If this function is enabled, the validator will take the notes as normal but then wait until the escrow line is toggled low/high before it will then give out the pulses per denomination as set. After the pulses have been given, the validator will wait for another low/high toggle until the full value of credit pulses are given.

For example, with a setting of 2 pulses per dollar, a five-dollar bill will give 2 pulses 5 times.

A Typical use of this option would be for a Pool table with a game price of \$1. You could insert a \$5 note and press a button that toggles the escrow line and releases the pool balls, this would then allow you to play the first game. The Validator holds onto the remaining credits until the game has finished and the button is pressed again allowing the next game to begin, this continues until all the credits have been used.

The busy line remains low throughout the whole process and the NV9USB+ remains inhibited until all pulses are given.

6.9.6 IF15 Interface

The IF15 is an interface that allows serial SSP to be used in machines without the need of updating the machine software. The IF15 is connected between the NV9USB+ and the host machine. The IF15 communicates with the validator in serial SSP which gives more security along the length of the cable. The IF15 should be mounted close to the host machine control board where the IF15 converts to the pulse connection.

Since the pulse protocol was added to the NV9 firmware it is no longer necessary to acquire this interface for the conversion.



7 ROUTINE MAINTENANCE

7.1 Introduction

The NV9 range of products have been designed to minimise any performance variation over time. Much of this is achieved by careful hardware and software design. However, depending upon the environment the validator and/or its modules may at some time require cleaning, belt changing or note path clearing.

7.2 Recommended Cleaning Intervals

Innovative Technology Ltd recommends cleaning the optical lenses every month or as required. Dirt, dust or other residue leads to bad note acceptance and other performance degradation.

Please refer to Second Level Support: [Section 9.6](#) for comprehensive cleaning instructions.

7.3 Recommended Belt Changing Intervals

Innovative Technology Ltd recommends that you change the drive belts of the NV9USB+ every 6-12 months or as required, dependant on environmental factors.

If dirt can be seen to be building up or if the belts themselves have had excessive use and are starting to wear, then this time period may not apply, and they would need to be swapped sooner.

Please refer to Second Level Support: [Section 9.7](#) for comprehensive belt changing instructions.



8 FIRST LEVEL SUPPORT

8.1 Bezel LED Flash Codes

The NV9USB+ supports various flash codes that are displayed to the user via the entry bezel. A detailed description of these can be found below.

Interface Flash Codes:

If you double press the red config button the bezel will flash a series of times. Below is a lookup table:

Flashes	Interface	Interface Settings											
		Cct plain	Cct 8-bit	No Escrow Timeout	DES	Low Power	High Speed	Pulse High	Pulse Low	Pulse per £	SIO start dis	Credit Hold	Binary
1	SSP												
2	Pulse							ms/10	ms/10	value		3	
3	MDB												
4	IF30												
5	IF31												
6	Cctalk	1	2	3	4								
7	SIO			3			1				2		
8	Parallel			2									1
9	SP4							ms/10	ms/10	value		3	
10	NS												
11	IF32						1						

Error Flash Codes

If the validator is an error state, the bezel will flash a combination of long and short flashes. The combination and their meanings can be found in the table below:

Number of LONG flashes	Number of SHORT flashes				
	1	2	3	4	5
1	Note Path Open	Note Path Jam	Unit not Initialized		
2		Cashbox jam			
3	Firmware checksum	Interface checksum	EEPROM checksum	Dataset checksum	Note Float incompatible
4	PSU too Low	PSU too High			



8.2 Status LED Flash Codes

In addition to the bezel flash codes of the NV9USB+ validator, each of the modules have their own status LED to report any errors/status events relating specifically to that module. These can also be found in the tables below:

Note Float

The status LED of the note float is behind the red button, located on the front of the module, as indicated in the image next to the table.

Flashes	Indicated Status / Error
Off	Normal Operation
Constant flash at 1Hz	Note Transport Error in Note Float
2 Flashes, pause (repeated)	Software Error
3 Flashes, pause (repeated)	Calibration Error
4 Flashes, pause (repeated)	Diverter Error
5 Flashes, pause (repeated)	Motor Timeout

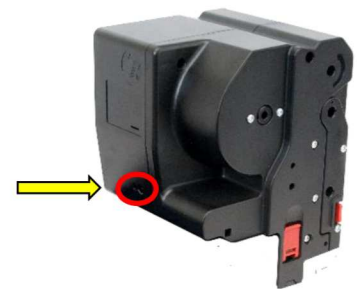

NV12

There is a status LED on the front of the NVR-280 printer module. This will signify errors related to the printer and will be a combination of yellow and red flashes. A table reference can be found below:

Flashes	Red			
Yellow	1	2	3	4
1	No connection	No Paper	Diverter not opened	Unknown error
2	Initialization Fail	Tab not found	Diverter not closed	
3	No Print Head	Load fail	Burst fail	
4	Ticket Path Open		Cut fail	
5			Unknown jam	



8.3 Configuration Button

The NV9USB+ and NV11+ both have a configuration button that has several functions available to the user. These are detailed below:

NV9USB+

- **Toggle between primary protocol and programming mode (SSP)**
 - Press and hold red config button
 - Wait until bezel illuminates, then release button.
 - Unit will flicker, reset, and will have toggled upon reset.
- **Check current protocol**
 - Double click the red config button.
 - Bezel will flash a set number of times
 - Refer to table above, in [section 8.1 – Bezel LED flash codes](#)
- **Enter configuration card mode**
 - Press red config button once
 - Unit will begin to flash, waiting for a configuration card to be inserted.
 - Press button again once, to cancel.
- **Cashbox full**
 - Empty the cashbox
 - Press red config button once
 - The stacker goes down checking that there is space again, if this is the case, the unit is enabled again

NV11+

- **Empty note float recycler and set counters to zero**
 - Press and hold red config button
 - Wait until bezel illuminates, keep hold of button.
 - Bezel LED will turn off, then release button.
- **Acknowledge clearing of jam**
 - If a jam has occurred in the note float (status LED flashing constant 1Hz) you will need to confirm that you've cleared it.
 - Press button once to acknowledge this action.
- **Cashbox full**
 - Empty the cashbox
 - Press red config button once
 - The stacker goes down checking that there is space again, if this is the case, the unit is enabled again



NV12+

The status LED on the printer head – described in the previous section – doubles up as a button. This button's behaviour differs depending on the DIP switches.

8.4 DIP Switches

The NV12+ also has a bank of switches. Each of their functions are detailed below.

Switch	Function
1	Change NVR-280 protocol Toggling the switch ON and then OFF, will toggle between SSP and ccTalk.
2	Not Used
3	Toggle NV9USB+ compatibility mode. When OFF, the button acts as the NV9USB+ red button. When ON, the button can be held to print a test ticket.
4	Safe Mode: Enables SSP with default settings When ON, upon powering the unit the printer head will start in SSP.



9 SECOND LEVEL SUPPORT

9.1 Introduction

9.2 Fault Finding Chart

You can use the below chart as an aid, to help resolve a number of common issues you might experience.

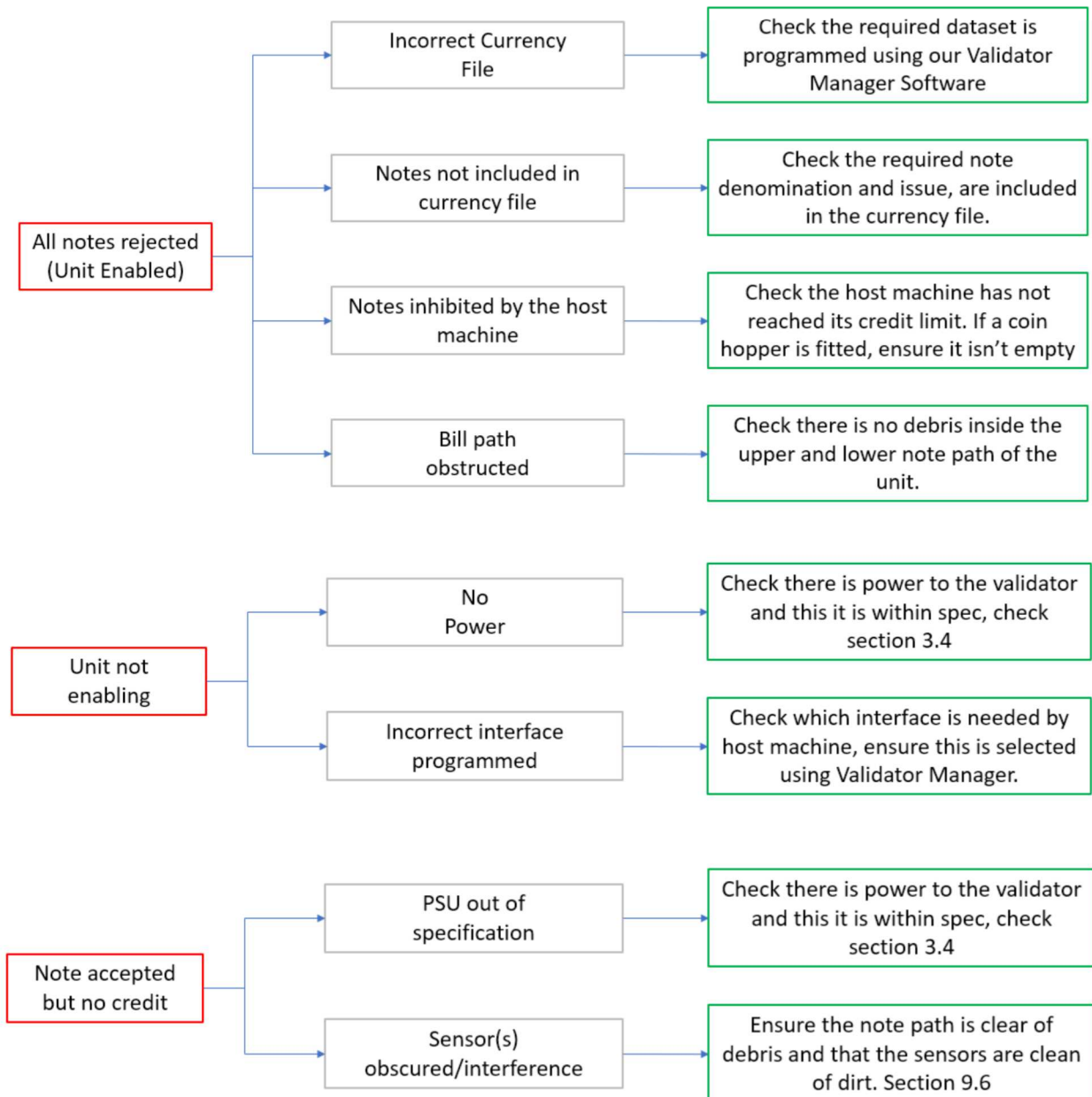

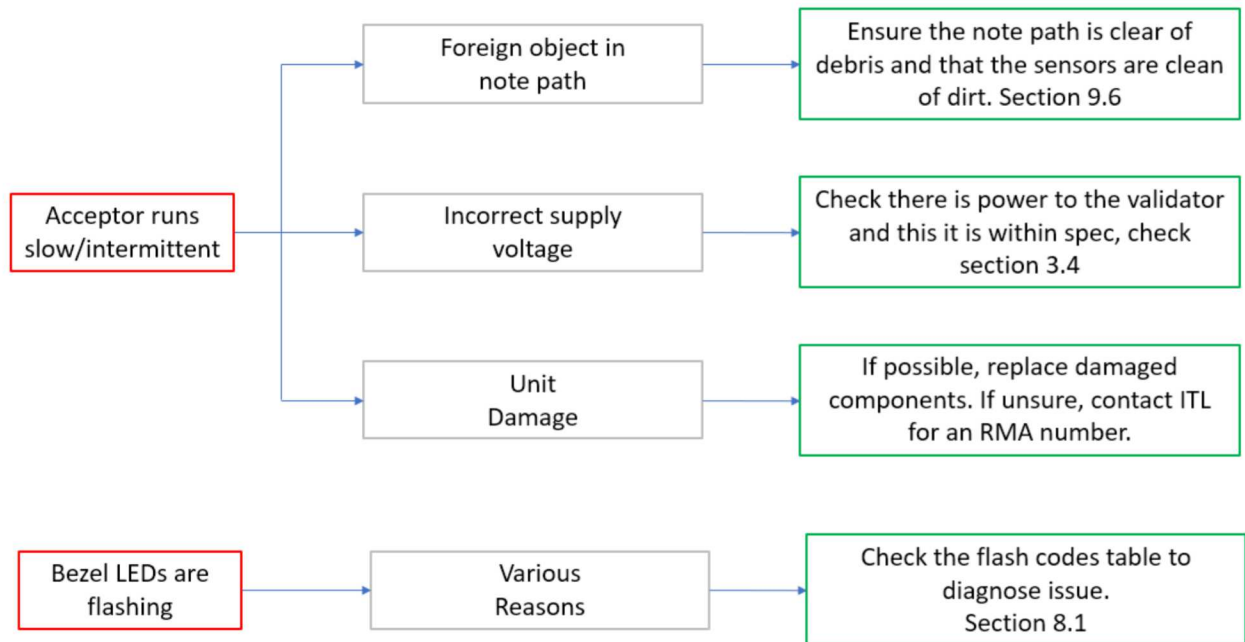

If you are unsure about the cause or how to resolve an issue, please contact the support team: support@innovative-technology.com

9.3 Clearing a Jam

1. Power Off

Either unplug the interface cable or switch of power to device/machine.

2. Open the Note Path

Slide the red catch to the left (1)
Lift the top half of the unit (2)



[<< Back to Contents](#)

3. Clear Jammed Note

If note can be seen in upper note path, remove note and proceed to next step.
If note is in lower note path, lift the lozenge.

Push grey release tab (1)

Lift lozenge unit (2)

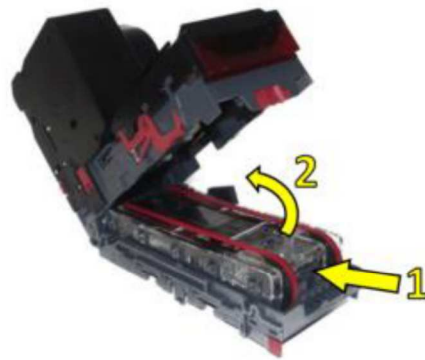

4. Re-apply Power

Close unit back up and re-apply power to unit.

It will reset and should no longer be flashing a jam error message.

9.4 Cleaning the Product(s)

9.4.1 NV9USB+/NV11+

1. Power Off

Either unplug the interface cable or switch of power to device/machine.

2. Open the Note Path

Slide the red catch to the left (1)

Lift the top half of the unit (2)



[<< Back to Contents](#)

3. Clean note path and sensors

Use a dry linen cloth and/or compressed air, to ensure there is no dirt or debris. Paying attention to sensor locations and drive belts.



9.4.2 Printer Head

1. Power Off

Either unplug the interface cable or switch of power to device/machine.

2. Remove Printer head

Use the printer head release latches to remove the printer head from the NV9USB+.

3. Clean printer head

Press in both door latches to open the back panel door.

Use compressed air to clean plastics of paper debris

4. Clean printer platen

Press the platen release latch to remove the component.

Use ethyl or isopropyl alcohol to clean the thermal printer.

TIP: use the compressed air before using the alcohol or after it has dried.



9.5 Changing the Drive Belts

1. Power Off

Either unplug the interface cable or switch of power to device/machine.

2. Open the Note Path

Slide the red catch to the left (1)
Lift the top half of the unit (2)



3. Remove Lozenge

Press grey release tab (1) to remove lozenge from validator.



4. Remove Old belts

With the lozenge removed, press both drive wheels inwards (2) to create slack in the belts.

This slack will allow you to remove belts from the lozenge.

TIP: Pushing the drive wheels down into your desk, helps.



5. Replace with new belts

Place new belts onto drive wheels, push them inwards to allow you enough slack to position belts into place.

TIP: Pushing the drive wheels down into your desk helps.



9.6 Clearing a Checksum Error

1. Bezel Flash Code

The flash code will indicate what type of checksum error the unit is reporting.

Long	Short	Checksum Type
3	1	Firmware
	2	Interface
	3	EEPROM
	4	Dataset

2. Re-program Unit

This type of error usually occurs if the file is corrupt, or an issue occurred during download. Retry download again. If error persists, please contact support.

9.7 Testing after an error has been cleared

1. Run/test unit

You can use our support tool, Validator Manager to run the unit and check operation.

Please refer to our GA02037 - Software Guide for full instructions on how to use ITL Validator Manager.

9.8 Re-initialisation of the sensors

1. Calibrate Unit

Use ITL Diagnostics tool, to re-calibrate the validator, using the appropriate calibration paper (LB00149)

Please refer to our GA02037 - Software Guide for full instructions on how to use ITL Diagnostics.



10 COMPLIANCES AND APPROVALS

10.1 EC Declaration of Conformity

- RoHS
- EN Directives
- UL
- REACH
- WEEE
- Central Bank Approvals



11 APPENDIX

11.1 Cable Drawings

11.1.1 CN00392 USB Type A to Validator Cable Assembly

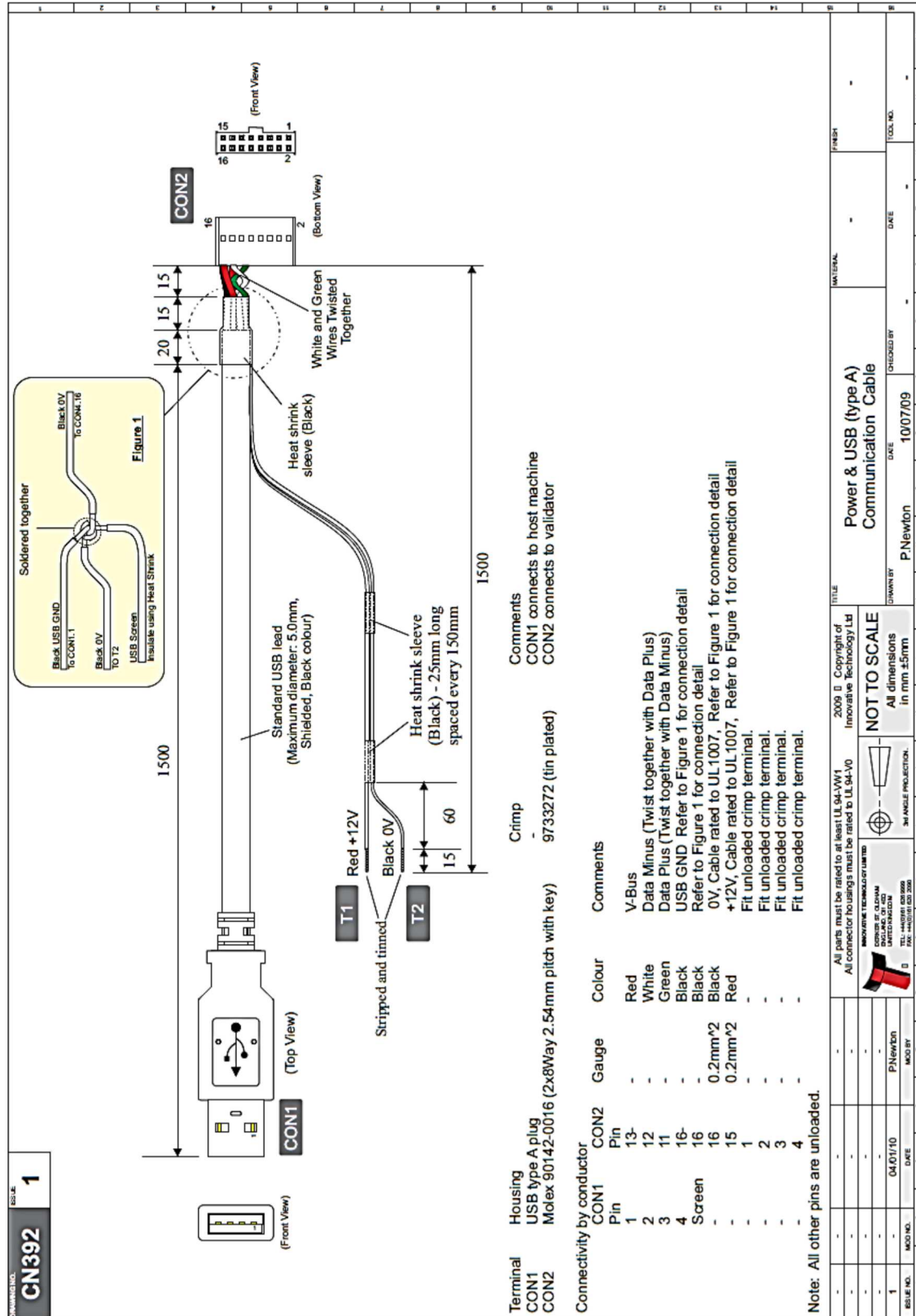

11.1.2 CN00214 USB A to USB B Cable Assembly

<p style="font-size: small;">DRAWING NO.</p> <h2 style="margin: 0;">CN00214</h2> <p style="font-size: small;">ISSUE</p> <h1 style="margin: 0;">1</h1>		<p style="text-align: center;">Vendor</p> <p style="text-align: center;">- - -</p>																																
<p style="text-align: center;">Parts List</p> <table border="1" style="width: 100%; border-collapse: collapse;"> <thead> <tr> <th style="text-align: left;">Item</th> <th style="text-align: left;">QTY</th> <th style="text-align: left;">Description</th> </tr> </thead> <tbody> <tr> <td>A</td> <td>1</td> <td>USB Type A Male Connector</td> </tr> <tr> <td>B</td> <td>1</td> <td>USB Shielded High Speed 2.0 Cable 28AWG/1P+28AWG/2</td> </tr> <tr> <td>C</td> <td>1</td> <td>USB Type B Male Connector</td> </tr> </tbody> </table>			Item	QTY	Description	A	1	USB Type A Male Connector	B	1	USB Shielded High Speed 2.0 Cable 28AWG/1P+28AWG/2	C	1	USB Type B Male Connector																				
Item	QTY	Description																																
A	1	USB Type A Male Connector																																
B	1	USB Shielded High Speed 2.0 Cable 28AWG/1P+28AWG/2																																
C	1	USB Type B Male Connector																																
<p style="text-align: center;">Comments</p>																																		
<p style="font-size: small;">All dimensions are in mm ±5mm, unless specified</p>																																		
<p style="font-size: x-small;">Note to Manufacturers Certificates are needed for the following: ■ RoHS compliance ■ UL94-V0 rated (connector housing) ■ UL1581-VW1 rated (all other parts)</p>																																		
<p style="font-size: x-small;">3rd Party Provisions NOT TO SCALE</p>																																		
<p style="font-size: x-small;">MANUFACTURED BY: INNOVATIVE TECHNOLOGY LTD 2000 WILSON ROAD, SUITE 100 MISSISSAUGA, ONTARIO L4X 1L7 CANADA TEL: +1 (416) 230-3000 FAX: +1 (416) 230-3000 © 2012 ALL RIGHTS RESERVED</p>																																		
<table border="1" style="width: 100%; border-collapse: collapse; font-size: x-small;"> <tr> <td style="width: 20%;">DRAWN BY</td> <td>C. Cardoza</td> <td style="width: 20%;">DATE</td> <td>15/03/2013</td> <td style="width: 20%;">MATERIAL</td> <td>-</td> <td style="width: 20%;">DATE</td> <td>-</td> </tr> <tr> <td>CHECKED BY</td> <td>A</td> <td>DATE</td> <td>15/03/2012</td> <td>PROPERTY</td> <td>-</td> <td>DATE</td> <td>-</td> </tr> <tr> <td>ISSUE NO.</td> <td>A</td> <td>MOD NO.</td> <td>-</td> <td>DATE</td> <td>-</td> <td>DATE</td> <td>-</td> </tr> <tr> <td>ISSUE BY</td> <td>C. Cardoza</td> <td>MOD BY</td> <td>-</td> <td>DATE</td> <td>-</td> <td>DATE</td> <td>-</td> </tr> </table>			DRAWN BY	C. Cardoza	DATE	15/03/2013	MATERIAL	-	DATE	-	CHECKED BY	A	DATE	15/03/2012	PROPERTY	-	DATE	-	ISSUE NO.	A	MOD NO.	-	DATE	-	DATE	-	ISSUE BY	C. Cardoza	MOD BY	-	DATE	-	DATE	-
DRAWN BY	C. Cardoza	DATE	15/03/2013	MATERIAL	-	DATE	-																											
CHECKED BY	A	DATE	15/03/2012	PROPERTY	-	DATE	-																											
ISSUE NO.	A	MOD NO.	-	DATE	-	DATE	-																											
ISSUE BY	C. Cardoza	MOD BY	-	DATE	-	DATE	-																											
<p>USB A to USB B Cable Assembly</p>																																		



11.1.3 WR00147 Smart Payout to NV200 Adaptor Harness

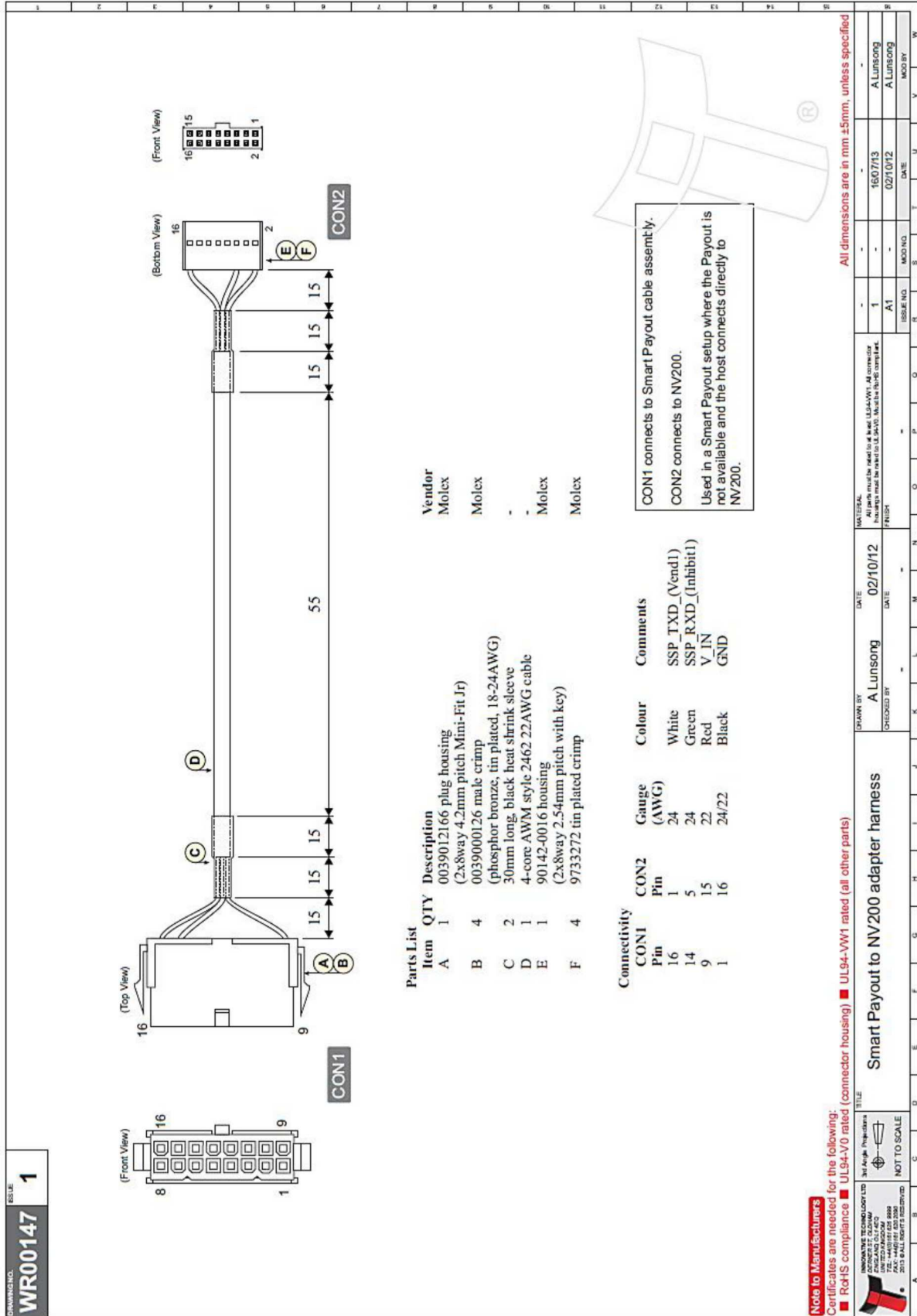

11.1.6 WR02040 Host USB to NV9/10 split to Rainbow Bezel Cable Assembly

DRAWING NO. **WR02040**

REV. **2**

Note to Manufacturers

Certificates are needed for the following:

- RoHS compliance
- UL94-V0 rated (connector housing)
- UL94-VW1 rated (all other parts)

Item	QTY	Description	P/N	Vendor	Connectivity	CON1 Pin	CON2 Pin	CON3 Pin	T1 Pin	T2 Pin	Gauge (AWG)	Colour	Comment
A	1	USB Type A plug	-	-	CON1	1	-	-	-	-	28	Red	USB Vbus +5V
B	1	USB Shielded High Speed 2.0 Cable 28AWG/1P+28AWG/2	-	-	CON1	13	-	-	-	-	28	White	USB Data -
C	1	20mm black heat shrink sleeve	-	-	CON1	12	-	-	-	-	28	Green	USB Data +
D	8	12mm black heat shrink sleeve (spaced every 150mm)	-	-	CON1	11	-	-	-	-	24	Black	GND
E	5	AWG 24 UL1061 stranded copper wire	-	-	CON1	16	-	-	1	-	28	Orange	NV11_RED
F	4	AWG 28 UL1061 stranded copper wire	-	-	CON1	3	-	-	2	-	28	Green	NV11_GREEN
G	1	14 way 2.54mm Pitch C-Grid III™ Receptacle	90142-0014	Molex (or Local Alternative)	CON2	4	-	-	-	-	28	Black	NV11_GND
H	11	Molex C-Grid III™ Crimp Terminals Tm, 28-28 AWG	90119-0120	Molex (or Local Alternative)	CON2	7	-	-	-	-	28	Orange	NV11_RED (INHIBITS)
J	4	Molex C-Grid III™ Crimp Terminals Tm, 22-24 AWG	90119-0109	Molex (or Local Alternative)	CON2	5	-	-	-	-	28	Orange	NV11_RED (INHIBITS)
K	2	Acetate cloth tape	-	-	CON2	7	-	-	-	-	28	Blue	NV11_BLUE
L	1	Black Braided sleeve	-	-	CON2	15	-	-	1	-	24	Red	+12V
M	1	16 way 2.54mm Pitch C-Grid III™ Receptacle	90142-0016	Molex (or Local Alternative)	CON3	-	-	-	-	-	-	-	-

Note
 CON2 pin16 GND pin should have two wires crimped together.
 CON2 pin 15 +12V pin should have two wire crimped together.
 The USB GND shield should be twisted and soldered to the ground leads as shown in Figure 1.
 CON1 connects to Host
 CON2 connects to validator
 CON3 connects to Bezel

Figure 1

Soldered together

Back USB GND

Back 0V

USB Shield

16 17 18 19 20 21 22 23 24 25 26 27 28 29 30 31 32 33 34 35 36 37 38 39 40 41 42 43 44 45 46 47 48 49 50 51 52 53 54 55 56 57 58 59 60 61 62 63 64 65 66 67 68 69 70 71 72 73 74 75 76 77 78 79 80 81 82 83 84 85 86 87 88 89 90 91 92 93 94 95 96 97 98 99 100

FRONT VIEW

TOP VIEW

FRONT VIEW

TOP VIEW

1500

1425

1445

20

15

10

20

15

60

15

CON1

CON2

CON3

T1

T2

13

14

15

16

17

18

19

20

21

22

23

24

25

26

27

28

29

30

31

32

33

34

35

36

37

38

39

40

41

42

43

44

45

46

47

48

49

50

51

52

53

54

55

56

57

58

59

60

61

62

63

64

65

66

67

68

69

70

71

72

73

74

75

76

77

78

79

80

81

82

83

84

85

86

87

88

89

90

91

92

93

94

95

96

97

98

99

100

10

20

15

60

15

1425

1445

20

15

13

14

15

16

17

18

19

20

21

22

23

24

25

26

27

28

29

30

31

32

33

34

35

36

37

38

39

40

41

42

43

44

45

46

47

48

49

50

51

52

53

54

55

56

57

58

59

60

61

62

63

64

65

66

67

68

69

70

71

72

73

74

75

76

77

78

79

80

81

82

83

84

85

86

87

88

89

90

91

92

93

94

95

96

97

98

99

100

10

20

15

60

15

1425

1445

20

15

13

14

15

16

17

18

19

20

21

22

23

24

25

26

27

28

29

30

31

32

33

34

35

36

37

38

39

40

41

42

43

44

45

46

47

48

49

50

51

52

53

54

55

56

57

58

59

60

61

62

63

64

65

66

67

68

69

70

71

72

73

74

75

76

77

78

79

80

81

82

83

84

85

86

87

88

89

90

91

92

93

94

95

96

97

98

99

100

10

20

15

60

15

1425

1445

20

15

13

14

15

16

17

18

19

20

21

22

23

24

25

26

27

28

29

30

31

32

33

34

35

36

37

38

39

40

41

42

43

44

45

46

47

48

49

50

51

52

53

54

55

56

57

58

59

60

61

62

63

64

65

66

67

68

69

70

71

72

73

74

75

76

77

78

79

80

81

82

83

84

85

86

87

88

89

90

91

92

93

94

95

96

97

98

99

100

10

20

15

60

15

1425

1445

20

15

13

14

15

16

17

18

19

20

21

22

23

24

25

26

27

28

29

30

31

32

33

34

35

36

37

38

39

40

41

42

43

44

45

46

47

48

49

50

51

52

53

54

55

56

57

58

59

60

61

62

63

64

65

66

67

68

69

70

71

72

73

74

75

76

77

78

79

80

81

82

83

84

85

86

87

88

89

90

91

92

93

94

95

96

97

98

99

100

10

20

15

60

15

1425

1445

20

15

13

14

15

16

17

18

19

20

21

22

23

24

25

26

27

28

29

30

31

32

33

34

35

36

37

38

39

40

41

42

43

44

45

46

47

48

49

50

51

52

53

54

55

56

57

58

59

60

61

62

63

64

65

66

67

68

69

70

71

72

73

74

75

76

77

78

79

80

81

82

83

84

85

86

87

88

89

90

91

92

93

94

95

96

97

98

99

100

10

20

15

60

15

1425

1445

20

15

13

14

15

16

17

18

19

20

21

22

23

24

25

26

27

28

29

30

31

32

33

34

35

36

37

38

39

40

41

42

43

44

45

46

47

48

49

50

51

52

53

54

55

56

57

58

59

60

61

62

63

64

65

66

67

68

69

70

71

72

73

74

75

76

77

78

79

80

81

82

83

84

85

86

87

88

89

90

91

92

93

94

95

96

97

98

99

100

10

20

15

60

15

1425

1445

20

15

13

14

15

16

17

18

19

20

21

22

23

24

25

26

27

28

29

30

31

32

33

34

35

36

37

38

39

40

41

42

43

44

45

46

47

48

49

50

51

52

53

54

55

56

57

58

59

60

61

62

63

64

65

66

67

68

69

70

71

72

73

74

75

76

77

78

79

80

81

82

83

84

85

86

87

88

89

90

91

92

93

94

95

96

97

98

99

100

10

20

15

60

15

1425

1445

20

15

13

14

15

16

17

18

19

20

21

22

23

24

25

26

27

28

29

30

31

32

33

34

35

36

37

38

39

40

41

42

43

44

45

46

47

48

49

50

51

52

53

54

55

56

57

58

59

60

61

62

63

64

65

66

67

68

69

70

71

72

73

74

75

76

77

78

79

80

81

82

83

84

85

86

87

88

89

90

91

92

93

94

95

96

97

98

99

100

10

20

15

60

15

1425

1445

20

15

13

14

15

16

17

18

19

20

21

22

23

24

25

26

27

28

29

30

31

32

33

34

35

36

37

38

39

40

41

42

43

44

45

46

47

48

49

50

51

52

53

54

55

56

57

58

59

60

61

62

63

64

65

66

67

68

69

70

71

72

73

74

75

76

77

78

79

80

81

82

83

84

85

86

87

88

89

90

91

92

93

94

95

96

97

98

99

100

10

20

15

60

15

1425

1445

20

15

13

14

15

16

17

18

19

20

21

22

23

24

25

26

27

28

29

30

31

32

33

34

35

36

37

38

39

40

41

42

43

44

45

46

47

48

49

50

51

52

53

54

55

56

57

58

59

60

61

62

63

64

65

66

67

68

69

70

71

72

73

74

75

76

77

78

79

80

81

82

83

84

85

86

87

88

89

90

91

92

93

94

95

96

97

98

99

100

10

20

15

60

15

1425

1445

20

15

13

14

15

16

17

18

19

20

21

22

23

24

25

26

27

28

29

30

31

32

33

34

35

36

37

38

39

40

41

42

43

44

45

46

47

48

49

50

51

52

53

54

55

11.4 Media Specifications

This section details the paper requirements for the NV12.

Specification

- Outer Diameter 80.0mm
- Inner Diameter 12.7mm
- Weight 80gsm

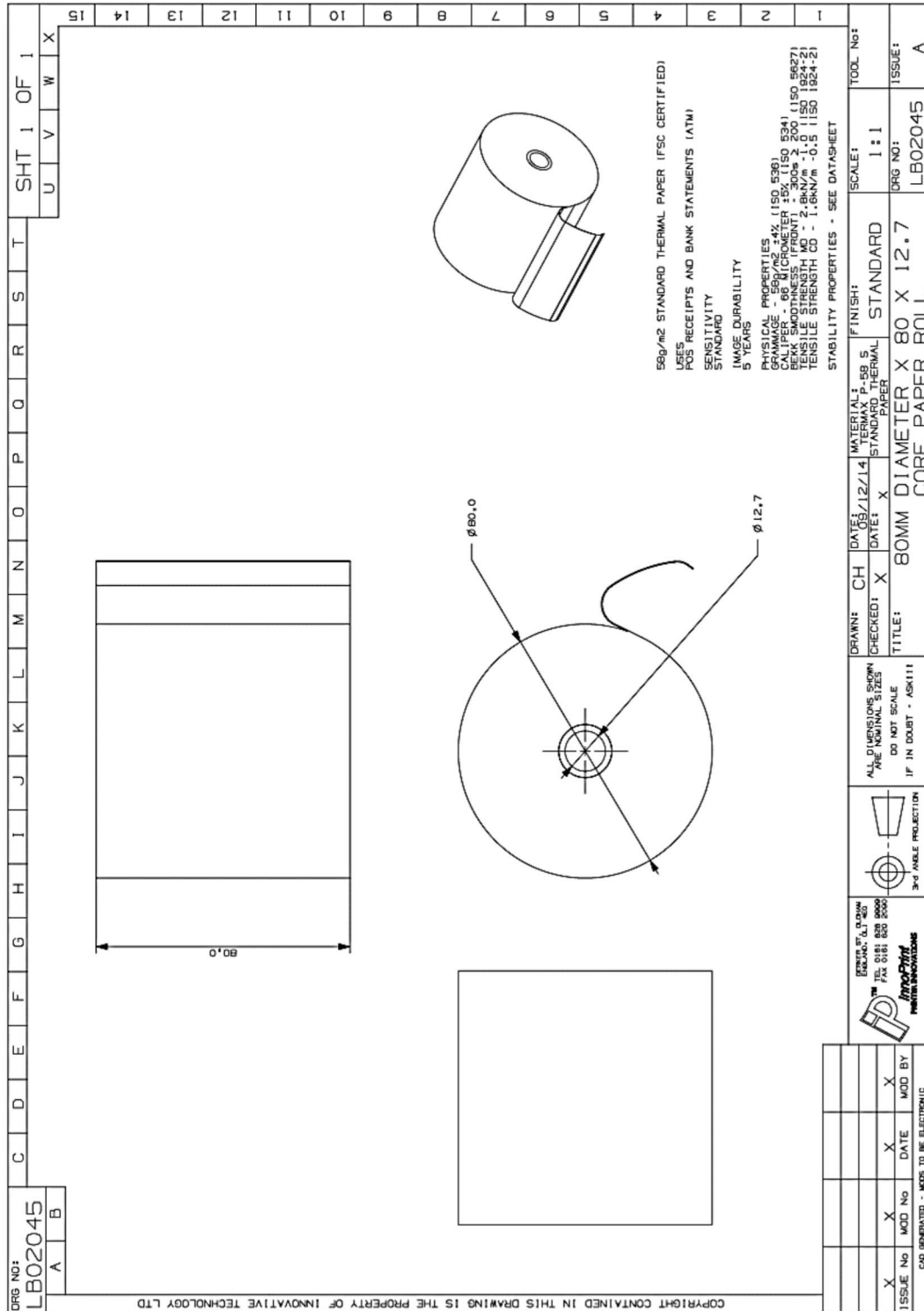

11.5 Switching to Programming Mode (SSP)

To switch the validator to SSP, you can utilise the red configuration button. This allows the user to toggle back and forth between its primary interface and SSP. The process is as follows:

- Firstly, check the current interface by double clicking the red button
- Unit will flash bezel an x number of times, to indicate what protocol it is.
 - a. 1 x flash is SSP
- If SSP is needed, press, and hold red button until bezel light illuminates
- As soon as the bezel illuminates, release button.
- Unit will flicker, reset, and start up again in SSP

11.6 ccTalk DES Encryption – Trusted Mode

1. Power Off

- Either unplug the interface cable or switch off the power.

2. Open Note path

- Slide the red catch to the left (1)
- Lift up the top half of the note path (2)



3. Power On

- With the note path open, apply power

4. Enter Trusted Mode

- Press and hold the configuration button until LED on underside of upper note path starts blinking.

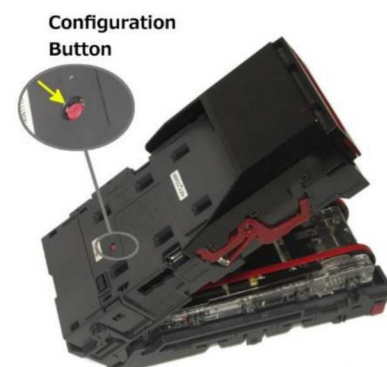

[<< Back to Contents](#)

5. Observe LED

- If successful, the LED described above will be blinking.
- The unit will remain in trusted mode for 30 seconds or until DES key has been exchanged.

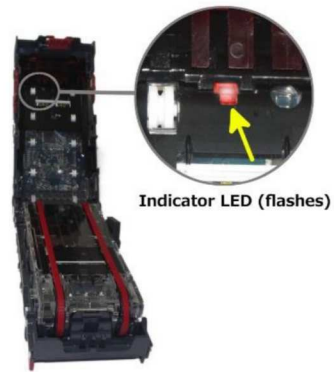

11.7 Escrow Control

The NV9USB+ has a single note escrow facility. This allows the validator to hold onto the note once validated, and then only stack the note into a cashbox when the host machine confirms that the Vend operation has been completed. If no confirmation of the Vend is received, then the note will be returned to the user after 30 seconds. If the host machine itself aborts the transaction by setting the corresponding inhibit input high, the note is returned immediately. The sequence of operation is as follows:

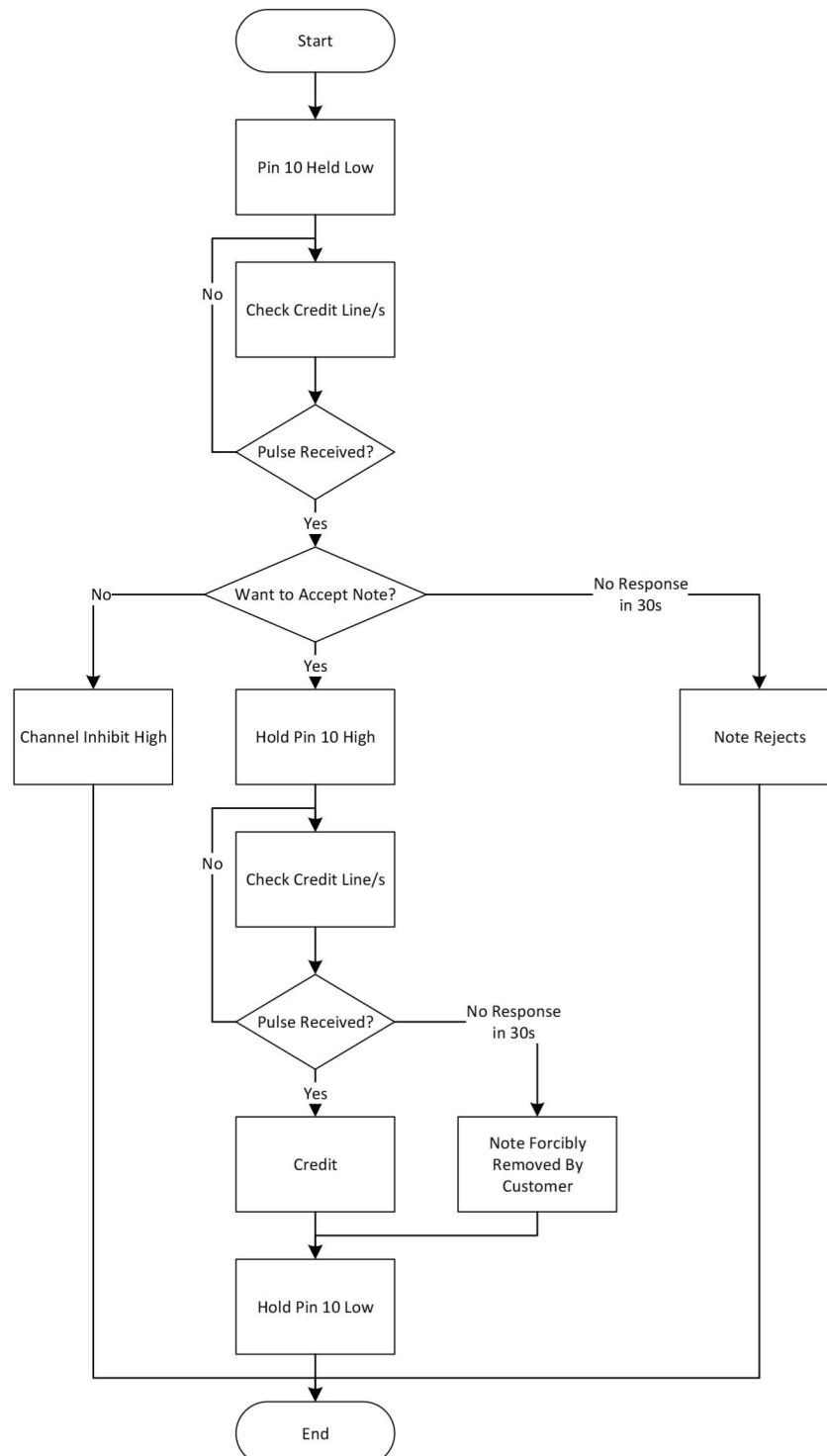

	Caution!
Only book the credit on the second vend pulse!	

11.7.1 Escrow Timing Diagram

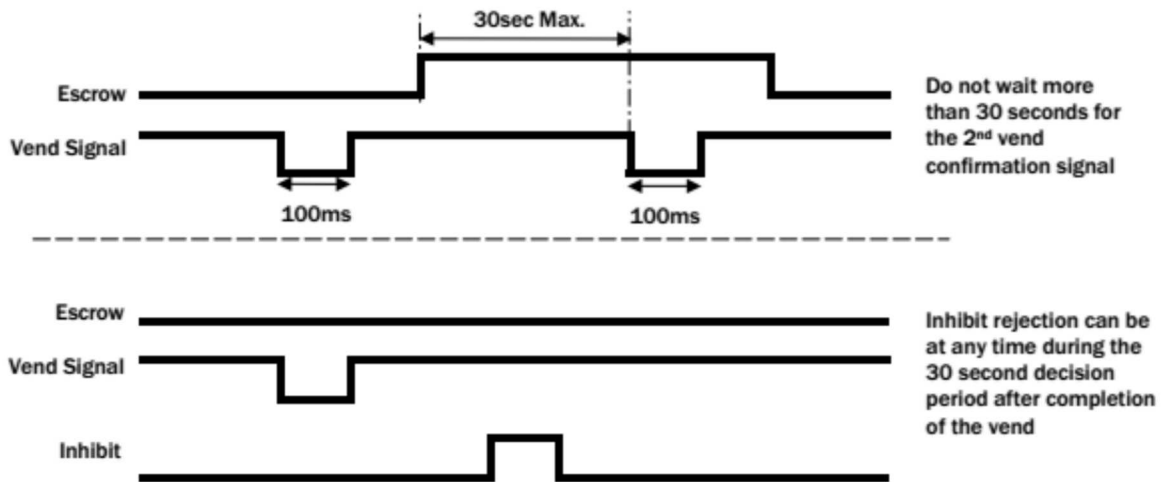

11.8 Low Power Mode Timing Diagram

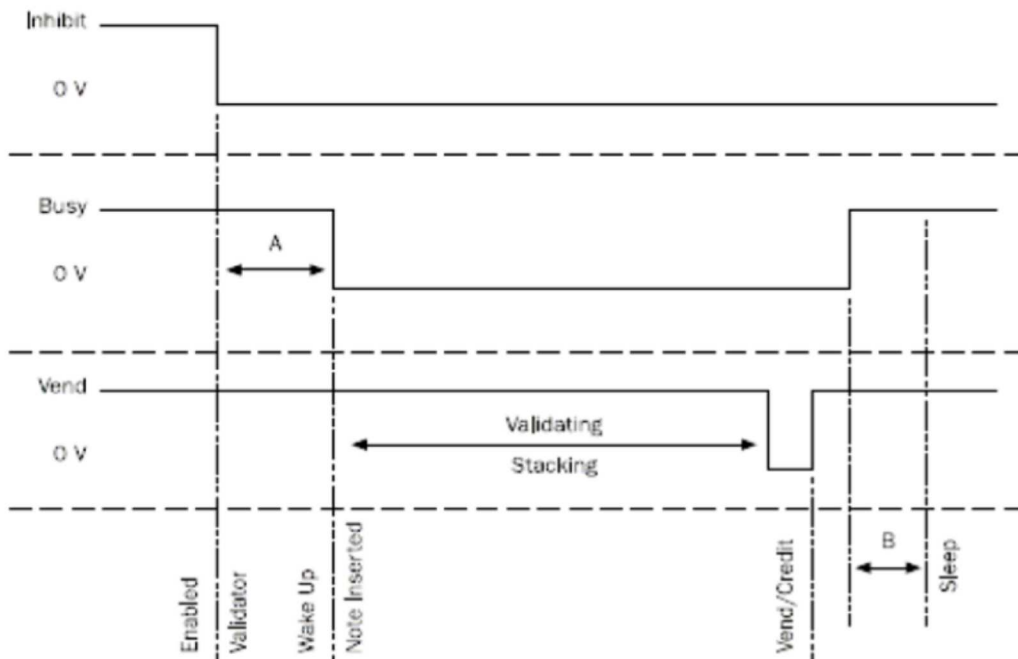

11.11 Programming via Configuration Card

Please consult ITL technical document GA959 for further information on configuration card programming – the GA959 document includes a printable template for the configuration card and this can be downloaded from the Support section of the ITL website.

The diagram shows a rectangular configuration card template with a width of 3.23" (82mm) and a height of 8.23" (210mm). At the top, it says "Insert this end first" with two arrows pointing upwards. Below this are two columns of checkboxes for "Select Interface": Parallel, Enabled pulse, SSP, SIO, Pulse, MDB, ccTalk, and Si 2. The next section is "Select bill disable" with checkboxes for CH 1 through CH 8. Below that is "Select pulse options" with checkboxes for High speed, Low speed, and pulse counts from # pulse x1 to # pulse x128. The final section is "General Options" with checkboxes for 8 bit ccTalk checksum, Credthold, ccTalk plain/ Binary, and No escrow timeout. At the bottom left is a red key icon, and at the bottom right are two black rectangular buttons. The text "GA 959 rev 1.4" is printed at the bottom center.

Configuration Card - instructions for use:

1. Cut card around the outline - check the measurements are as printed. Make sure that 'Page scaling' is set to 'None' in your print options to ensure the correct size.
2. Fill in sections as required. Take care to fill in the sections correctly, keep inside the lines and fill boxes fully as shown here:



GOOD



OK



BAD
3. Power-up the validator and wait until it resets.
4. Press the configuration button once to enter programming mode (the bezel LEDs should flash at 1 second intervals).
5. Insert the card into the validator face up and, in the direction, indicated by the arrows.
6. The configuration card will be ejected and if the configuration was good the bezel LEDs will flash at a fast rate while programming takes place. After completion of programming the validator will reset.

